

Number Scoops



Copy each type of scoops on different colored paper so that when the cones and scoops are matched, there is one of each color or flavor.

Included:

Cones with numbers 0 – 20, tens from 30 – 110

Scoops with number words

Scoops with base 10 blocks

Scoops with number of tens and ones

Scoops with addition sentences based on tens and ones

Scoops with tally marks

Blank scoops to add your own ideas

To make the game self-checking:

Put a matching mark or sticker on the back of each number set. Example: The 1 cone and all the 1 scoops will have the same star. The 5 cone and all the 5 scoops will have the same heart. Etc.



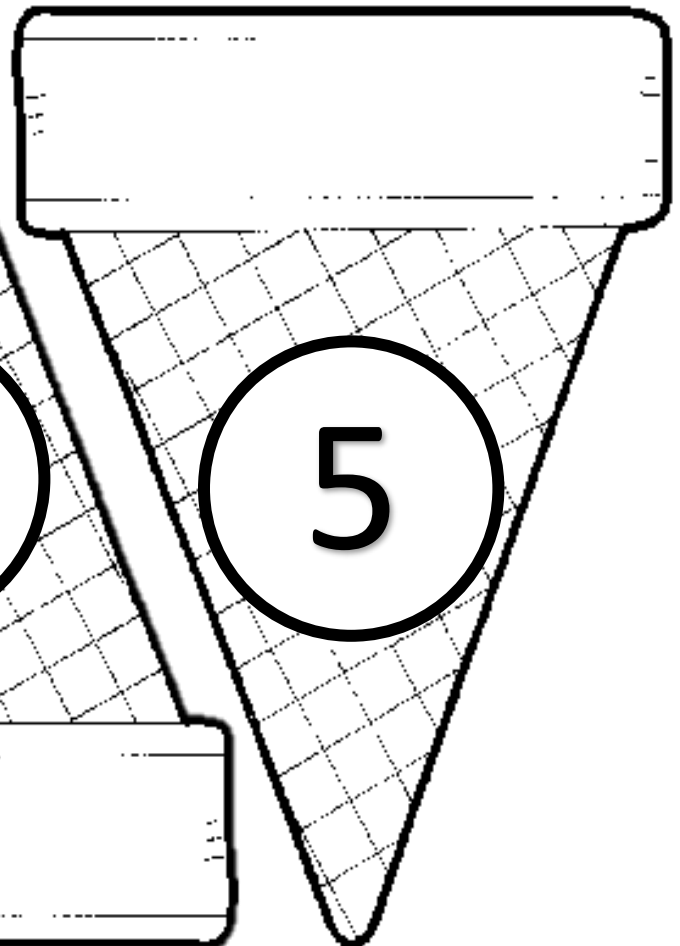
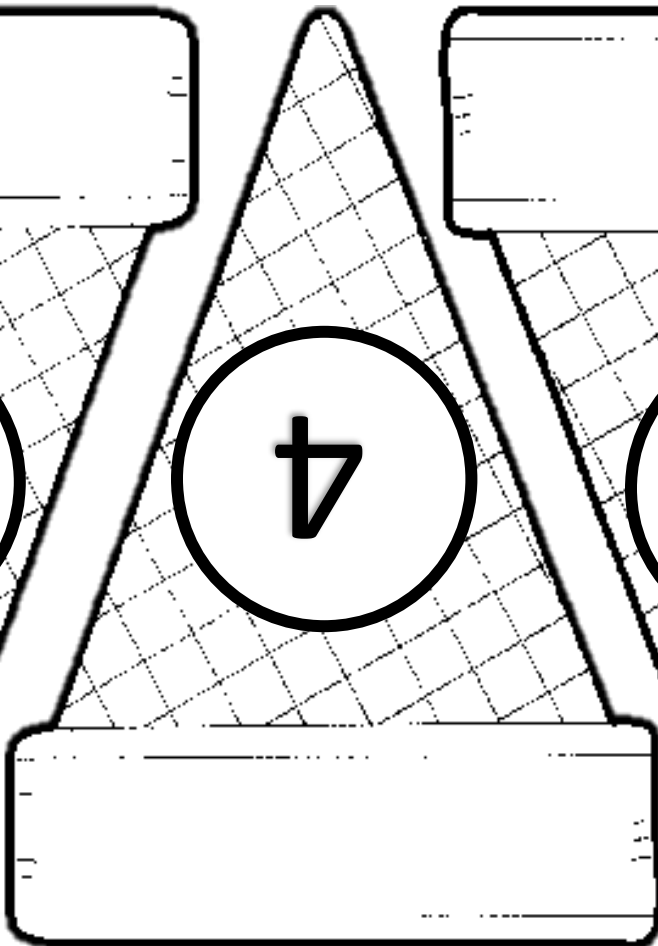
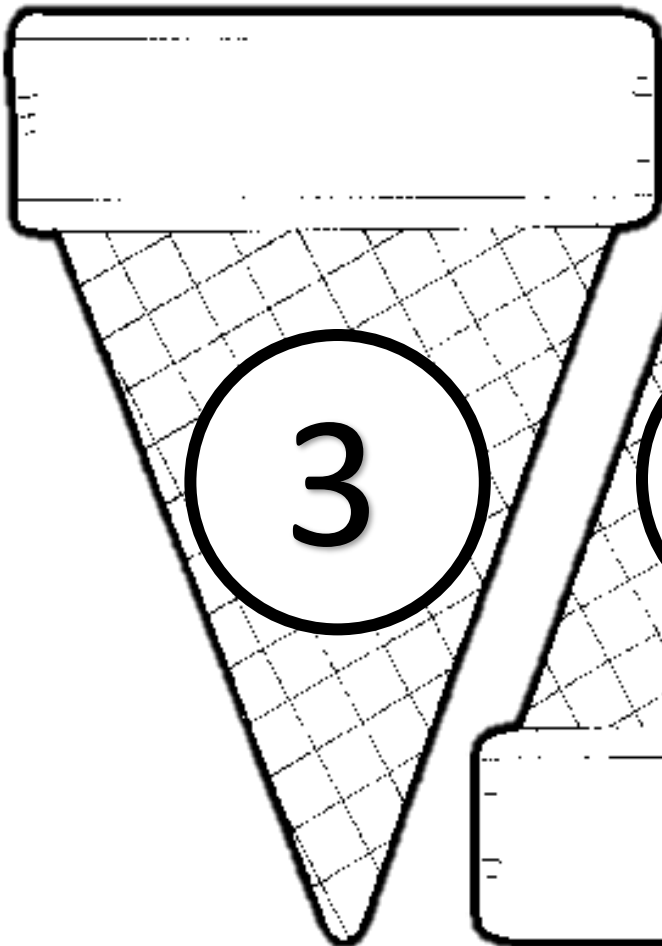
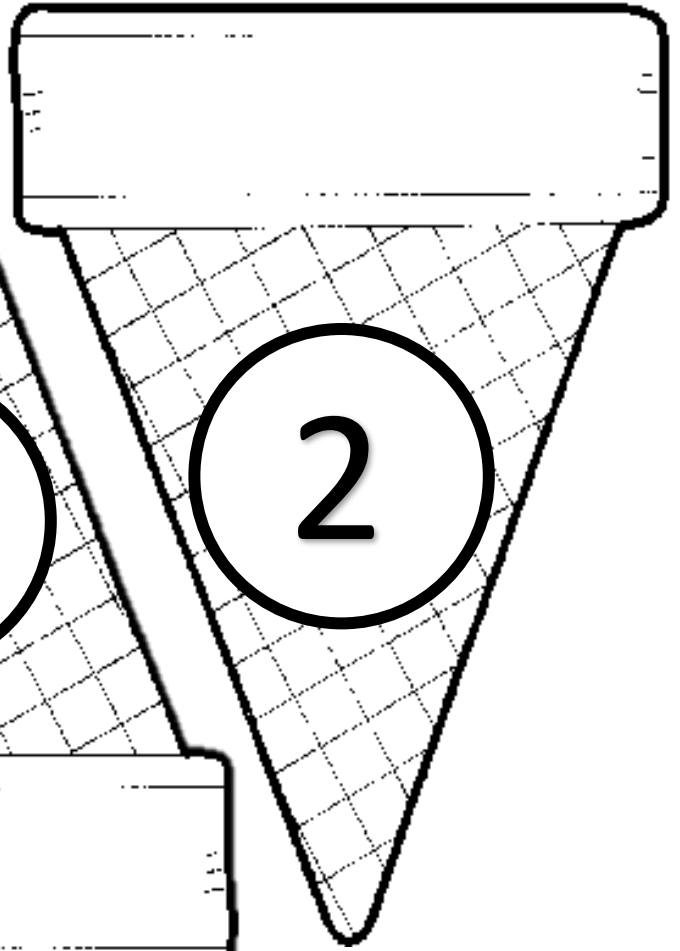
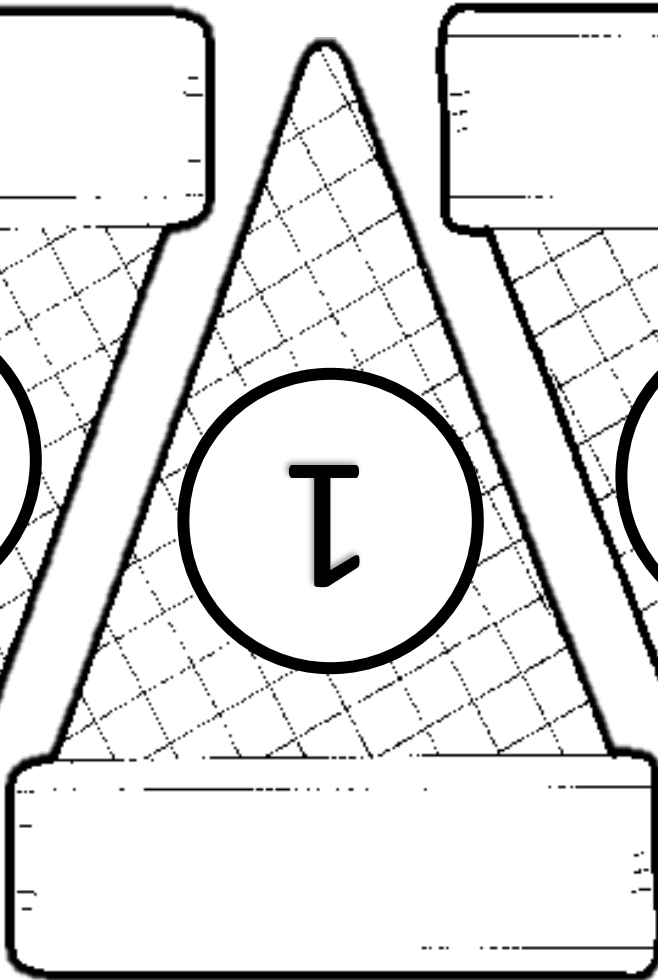
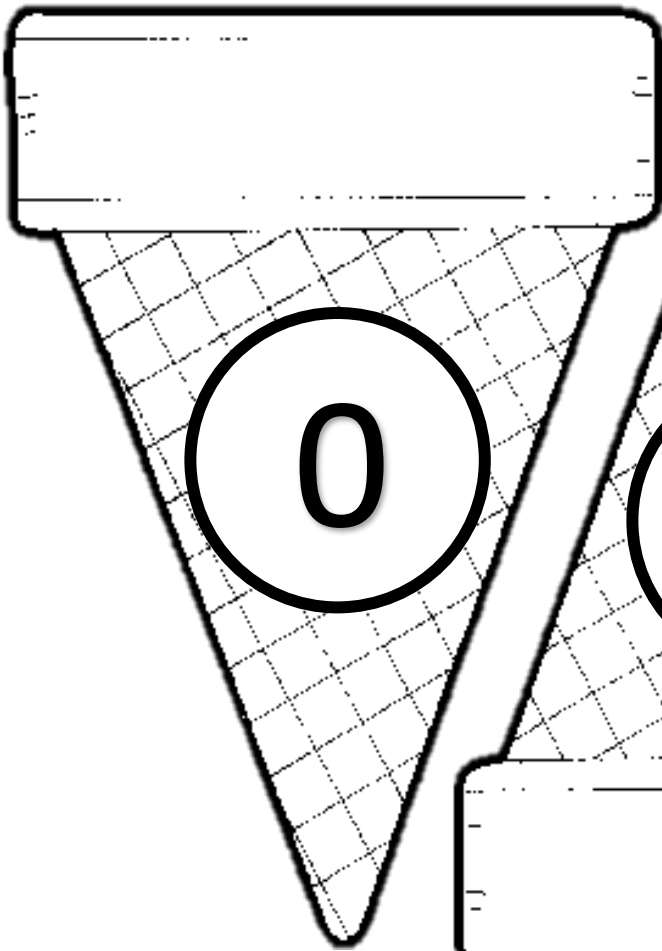

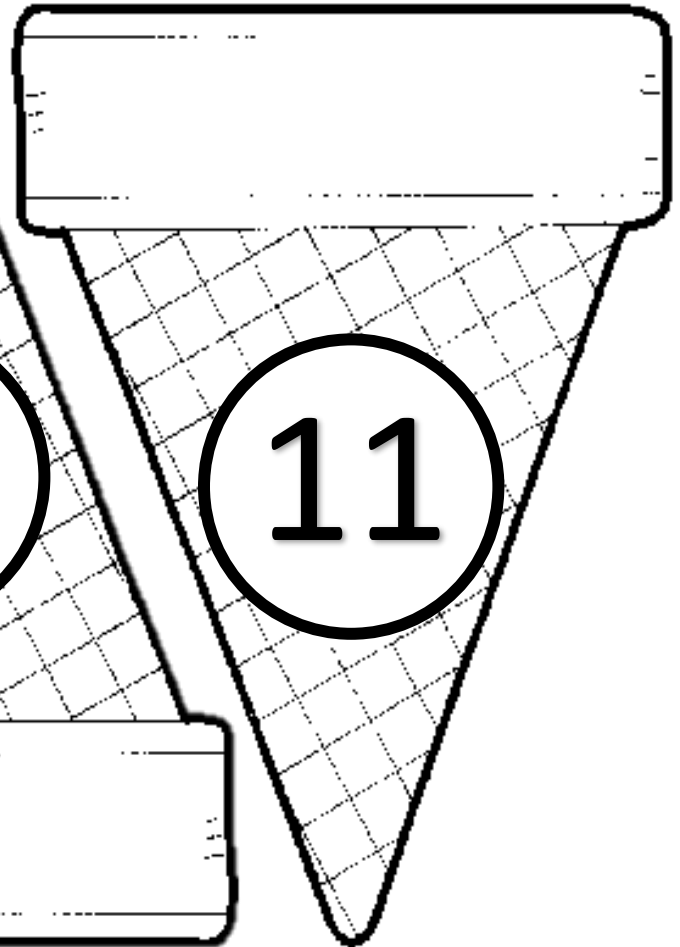
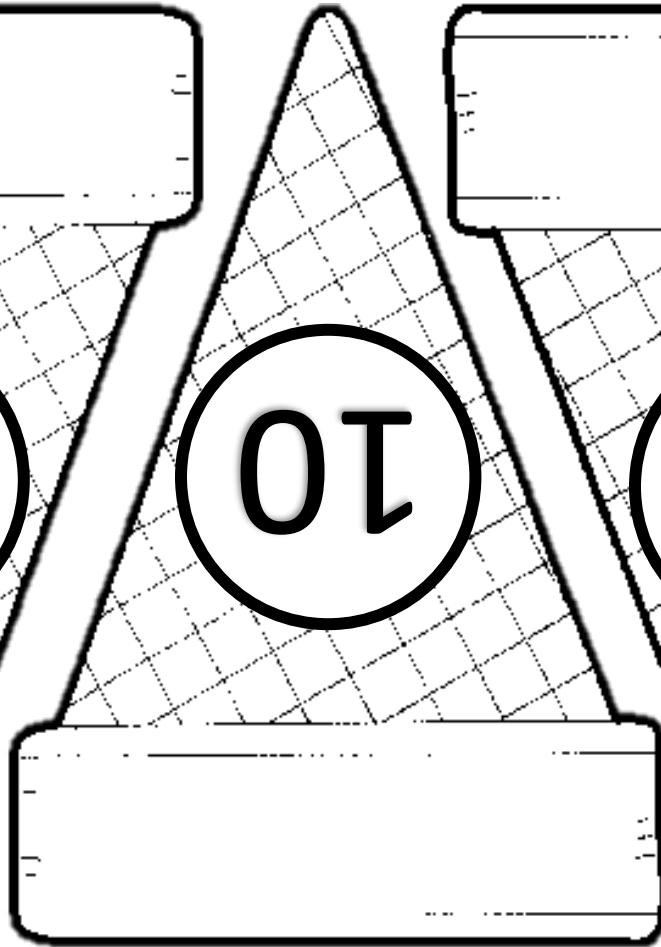
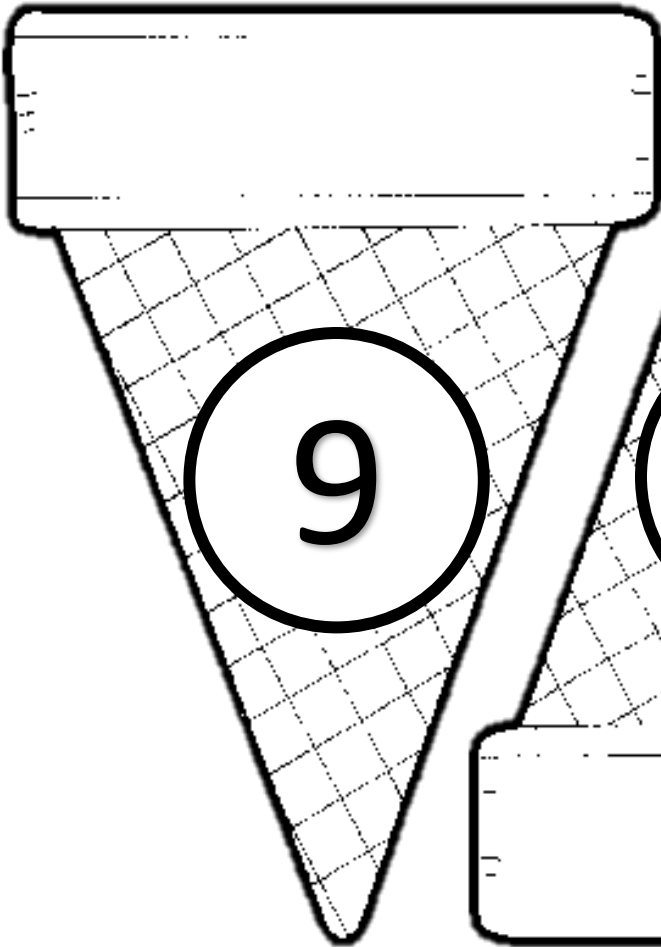
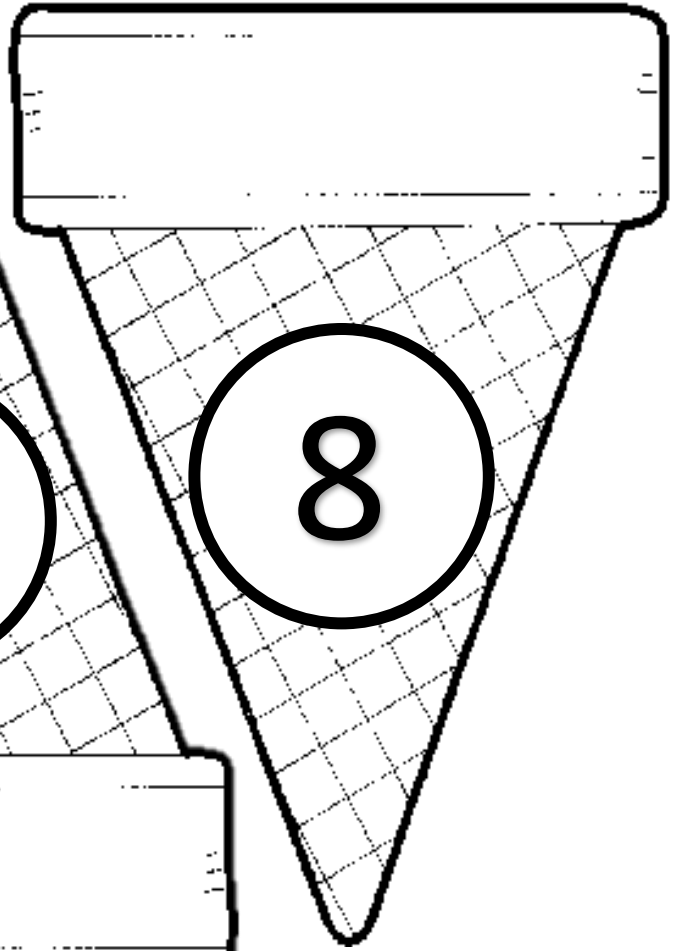
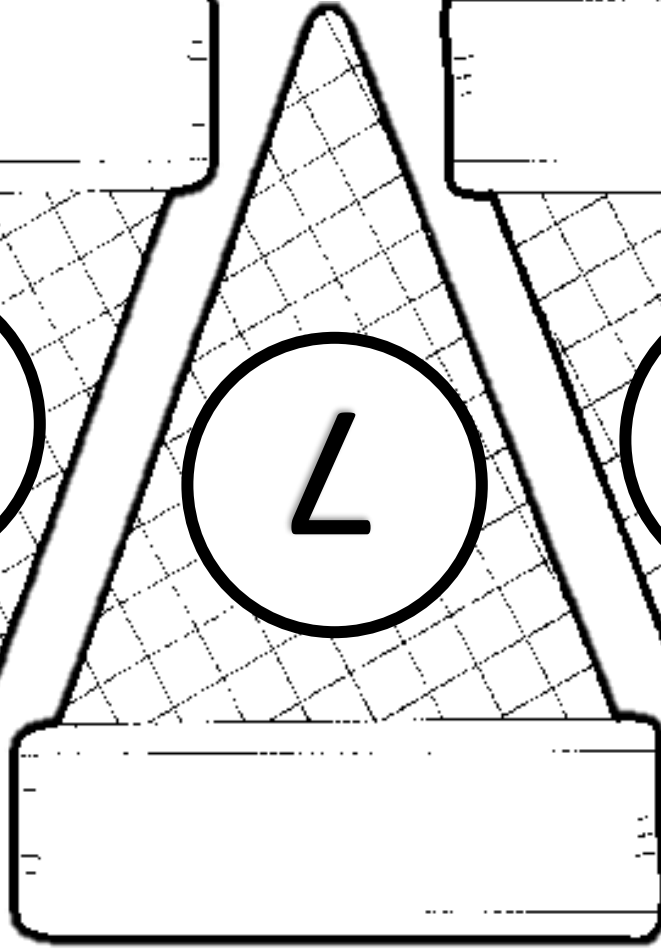
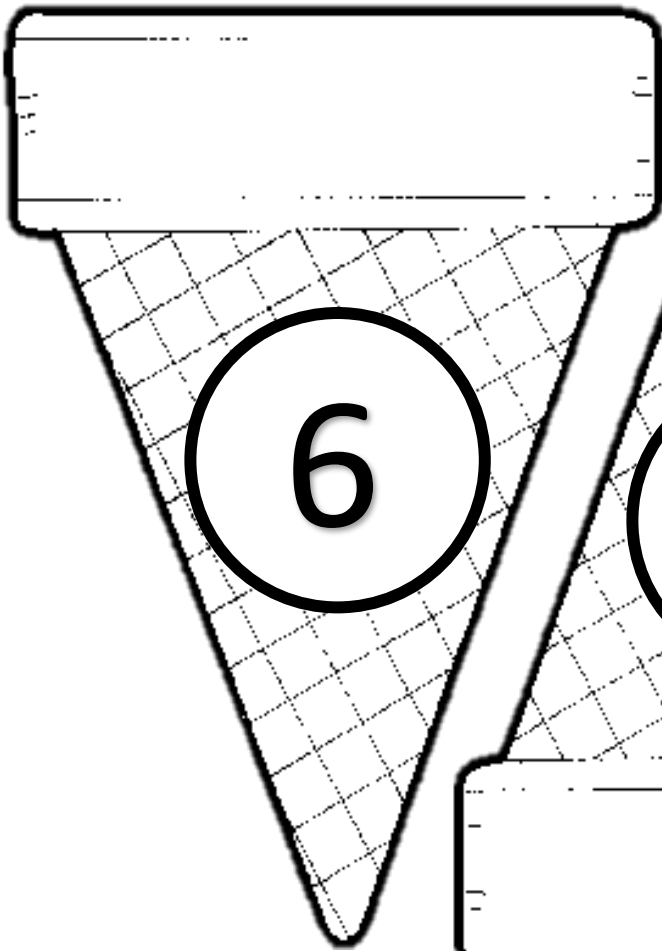

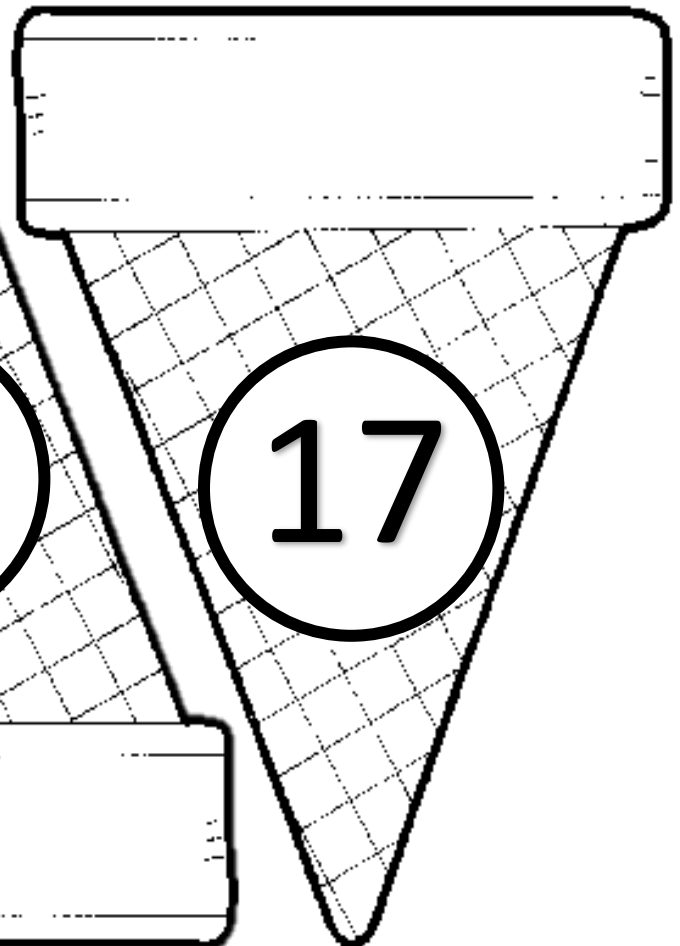
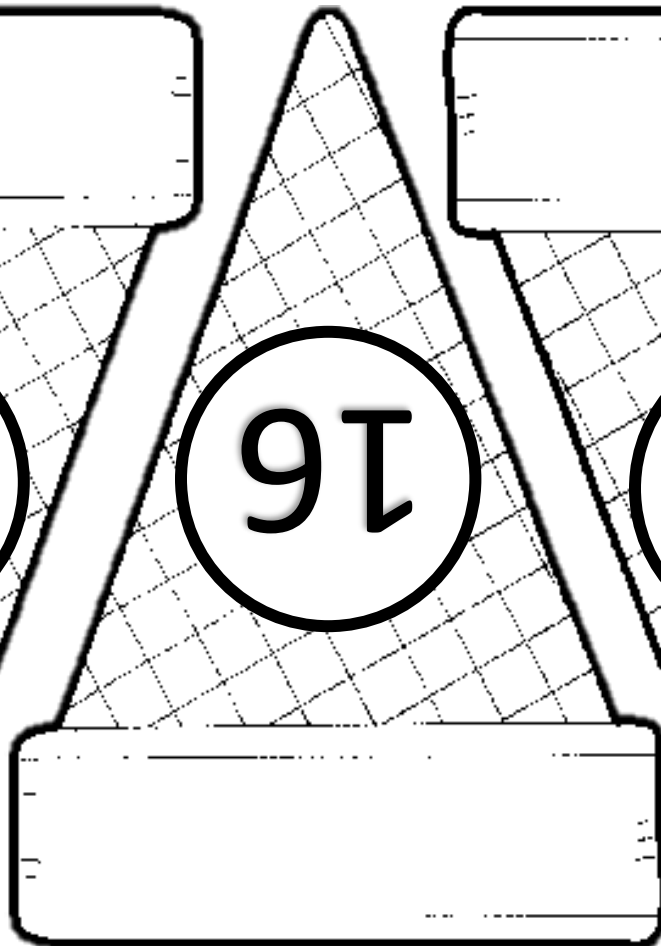
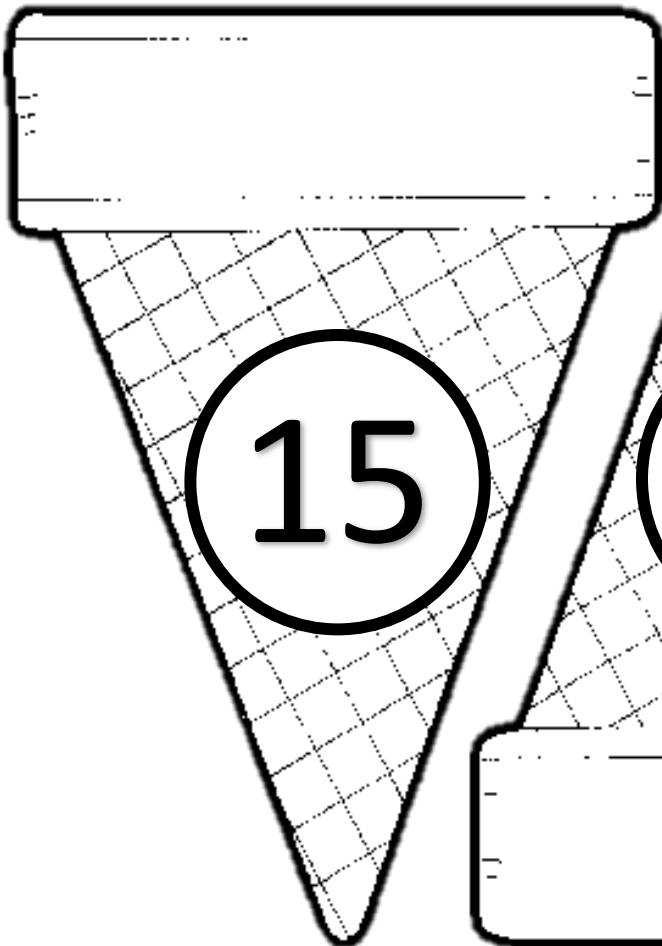
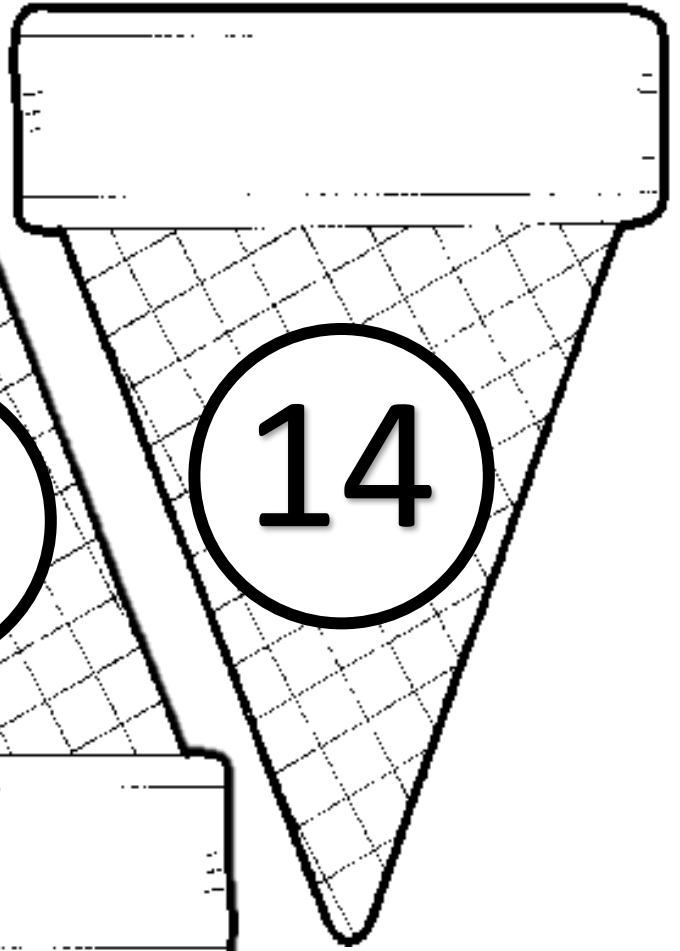
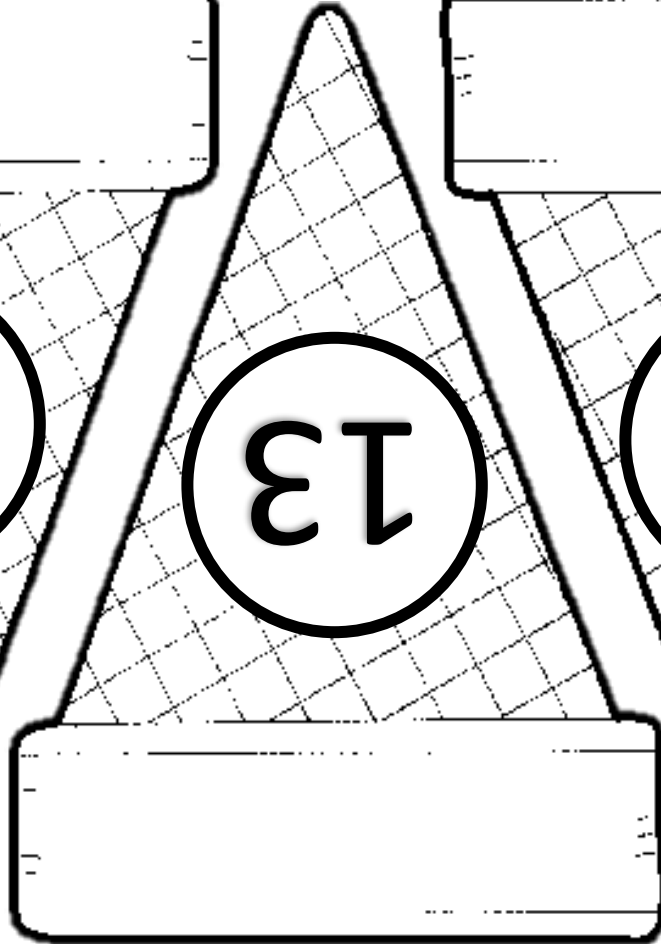
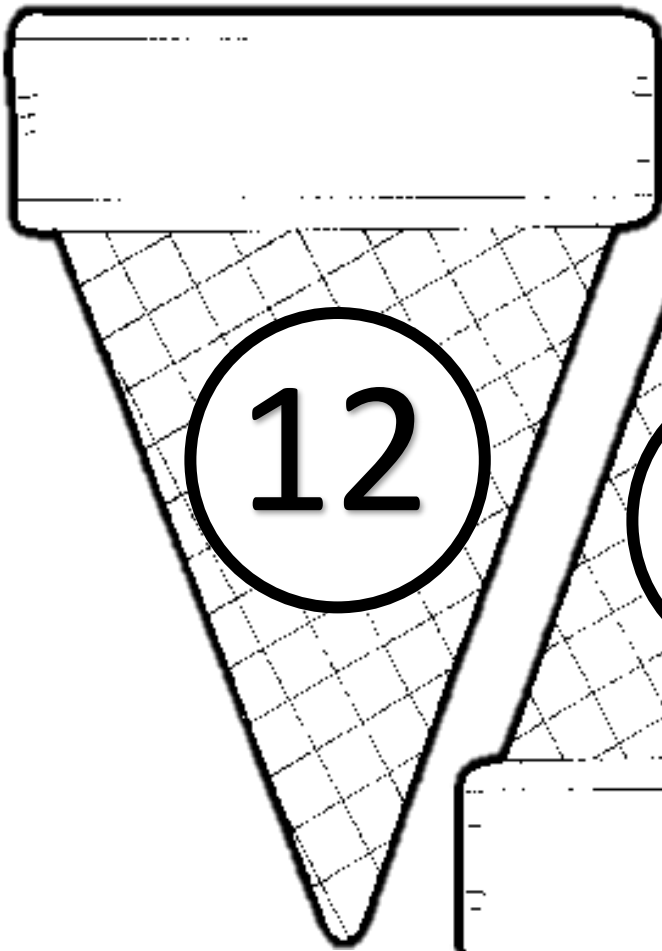

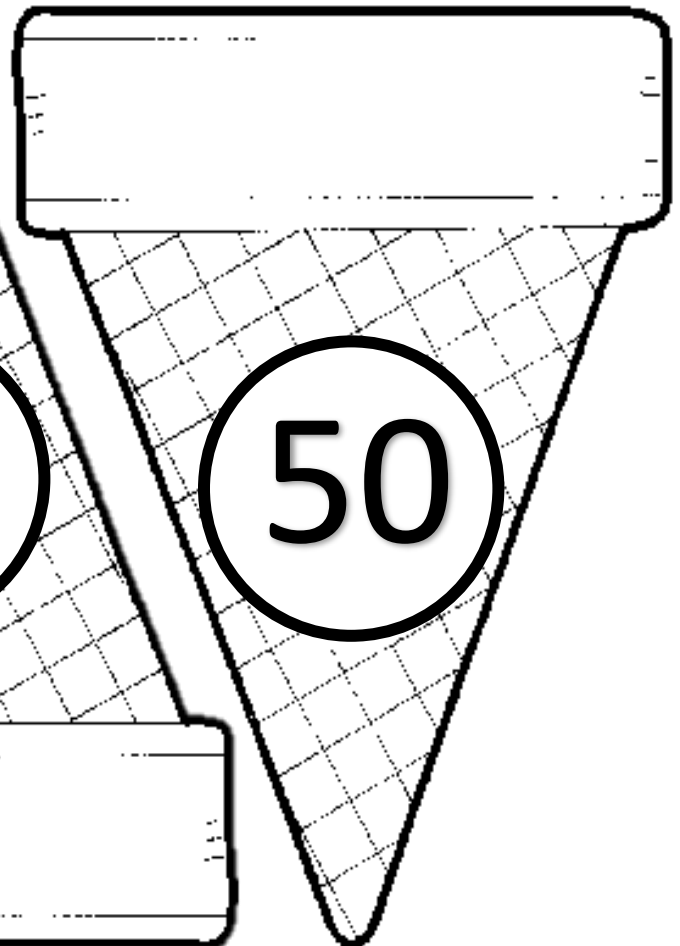
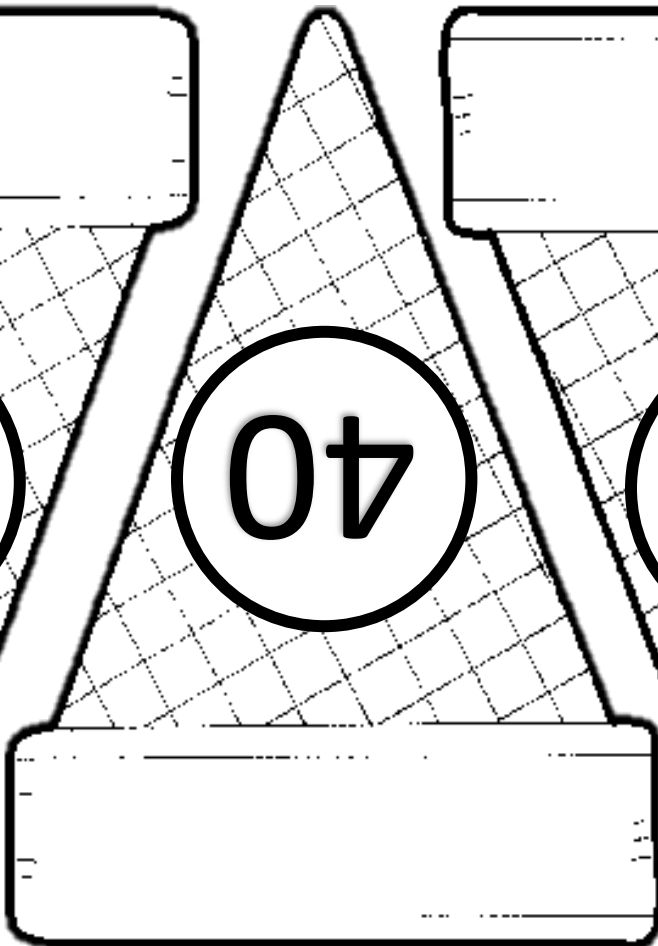
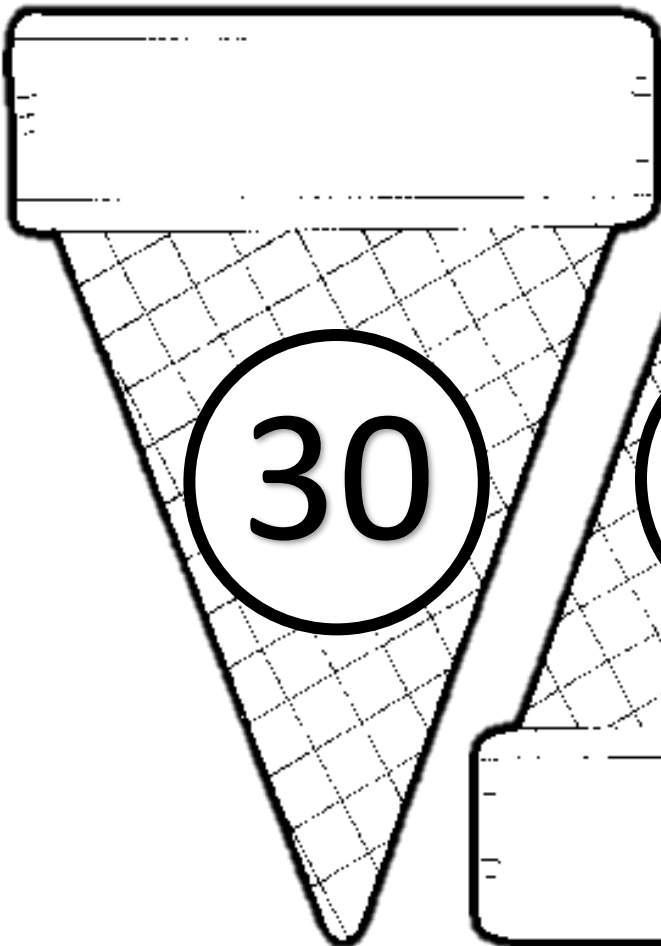
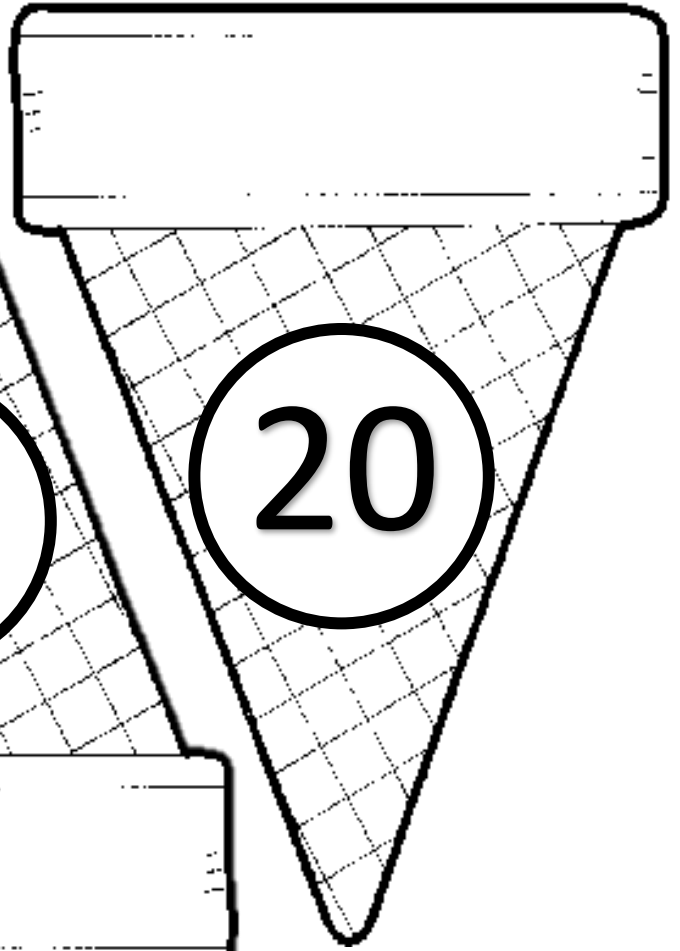
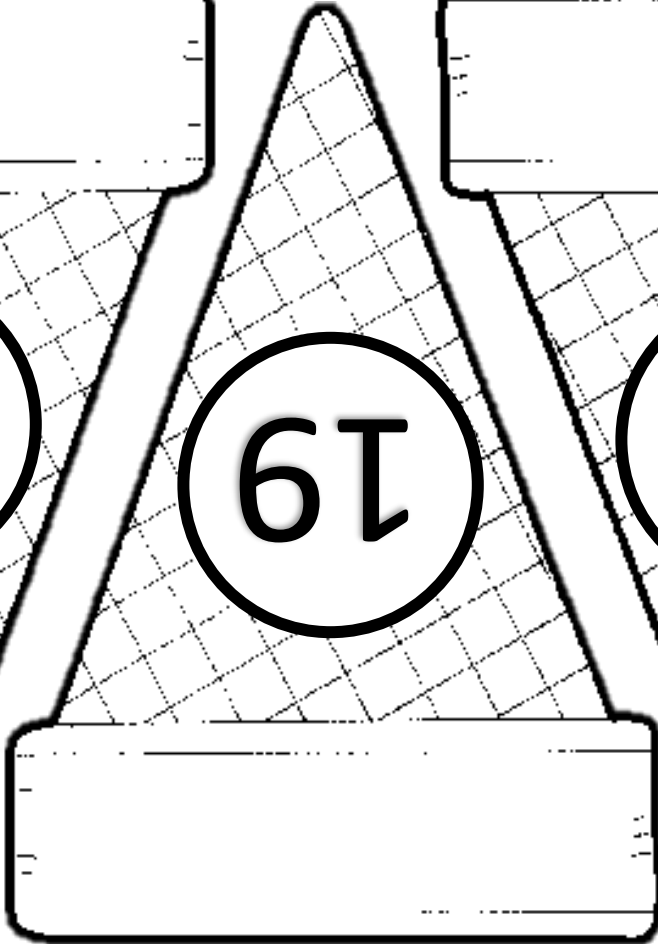
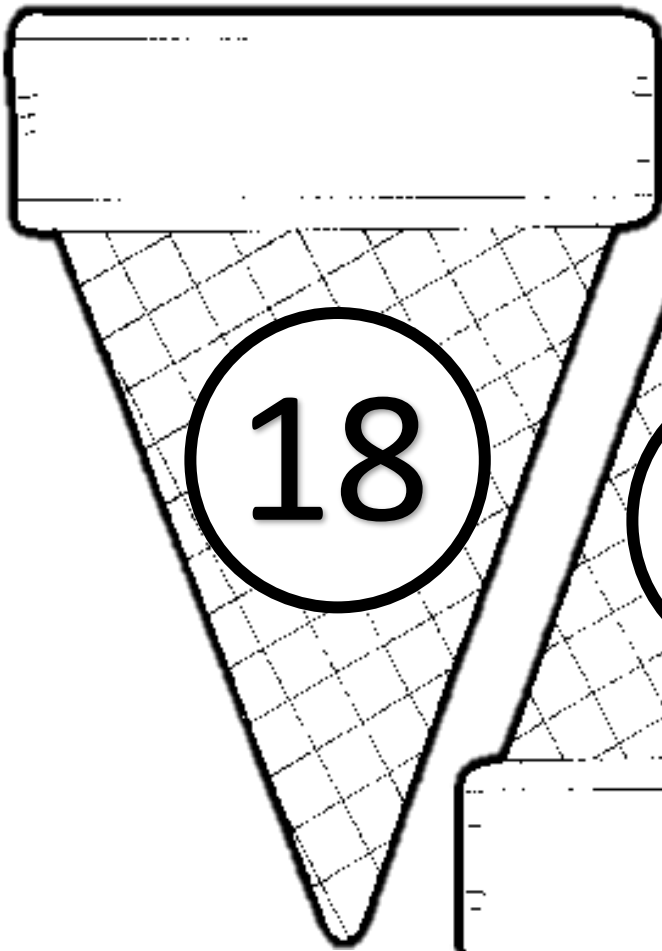

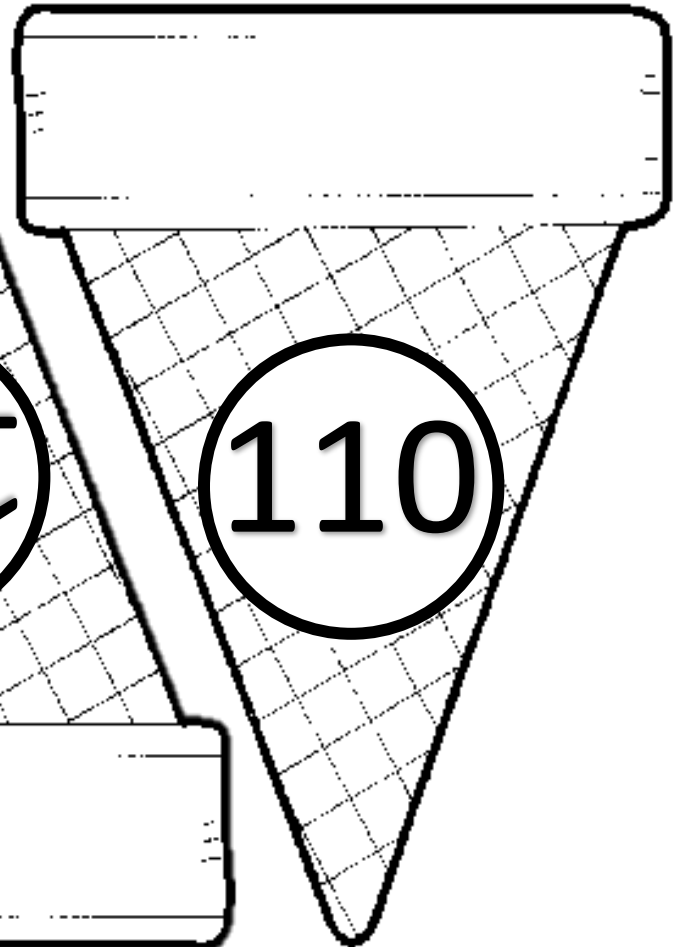
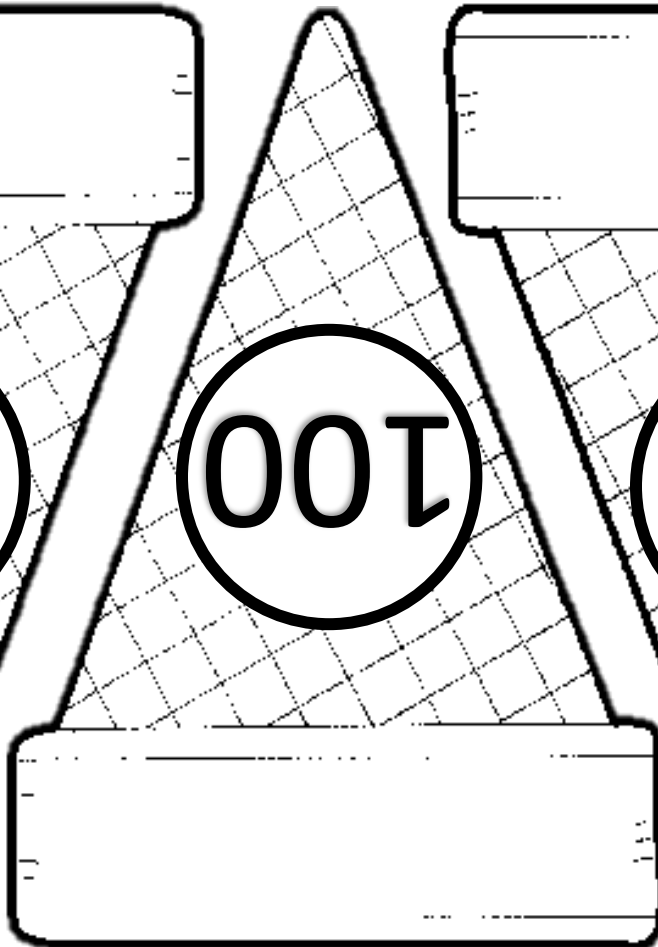
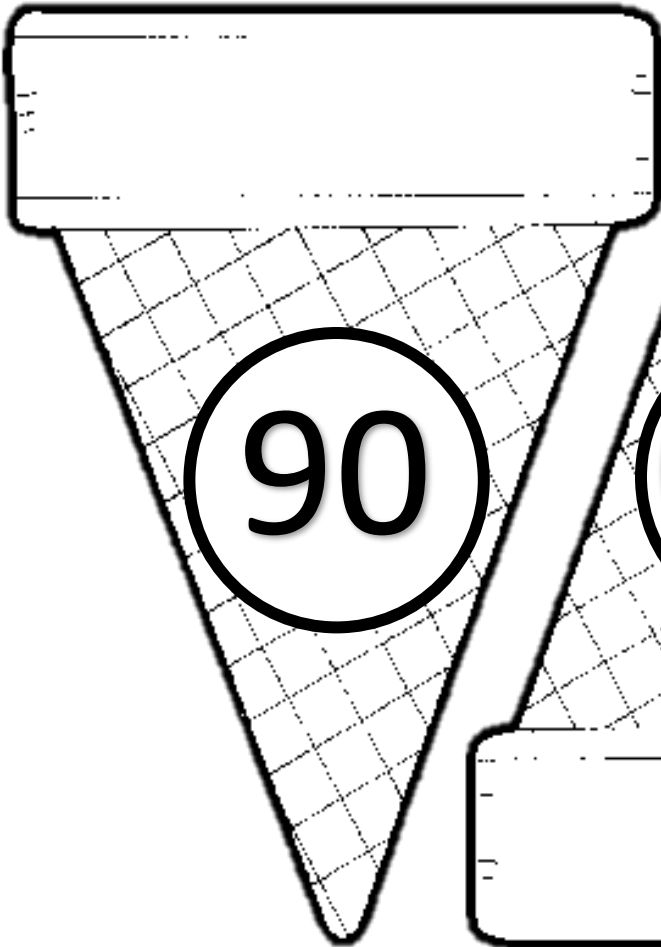
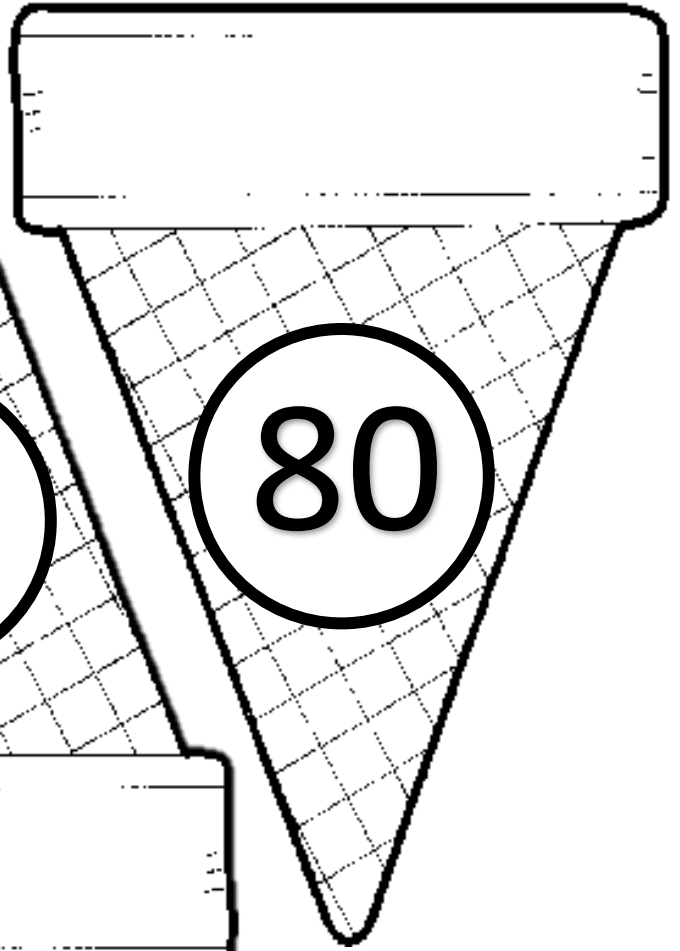
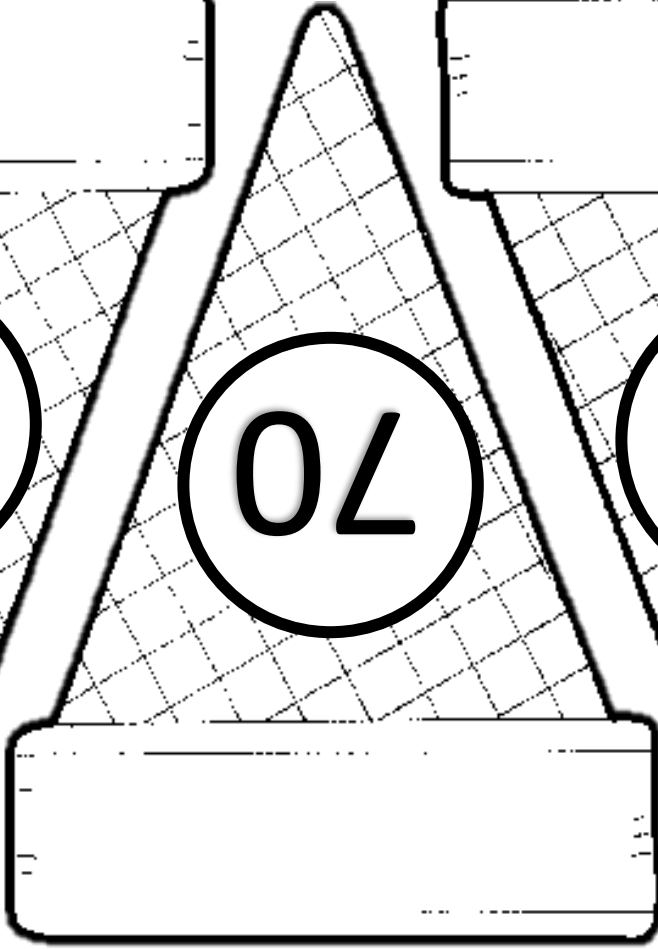
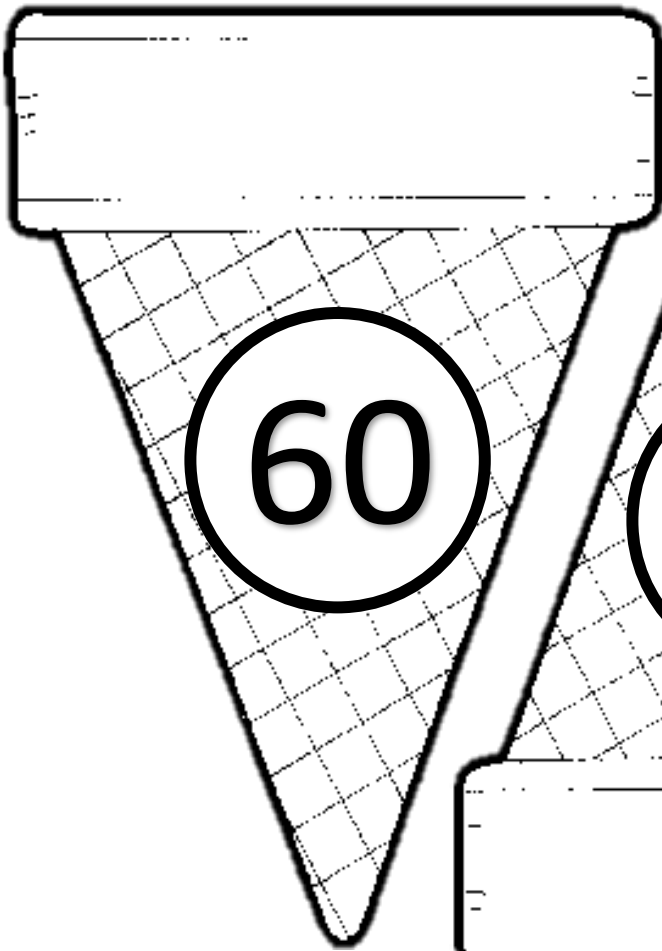



zero



one



two



three



four



five



six



seven



eight



nine



ten



eleven



twelve



thirteen



fourteen



fifteen



sixteen



seventeen



eighteen



nineteen



twenty



thirty



forty



fifty



sixty



seventy



eighty



ninety



one hundred



one hundred

ten

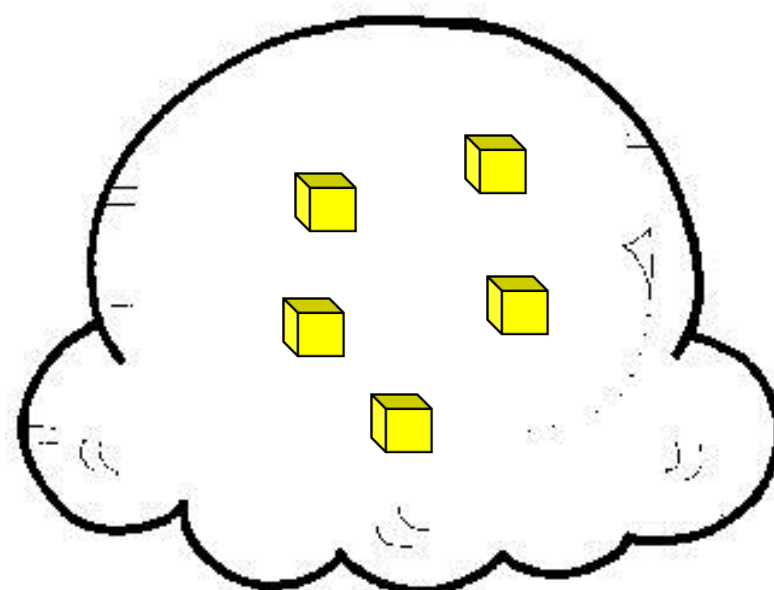
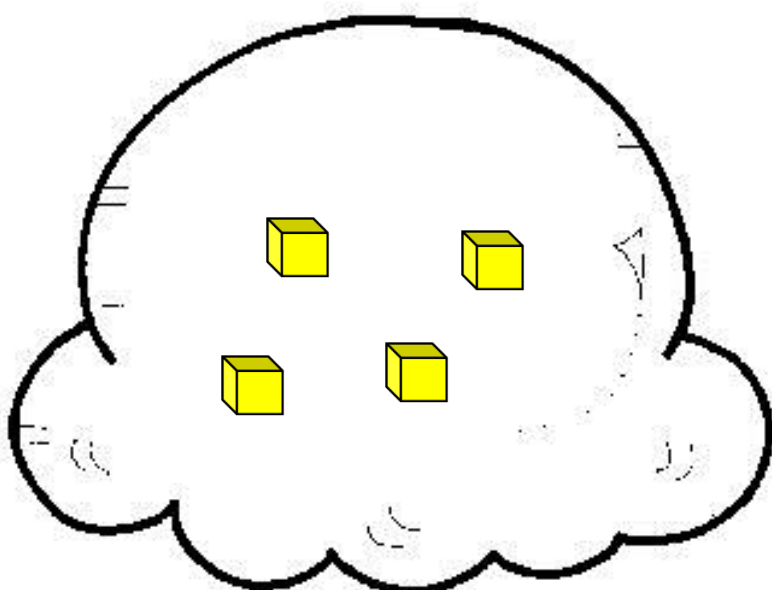
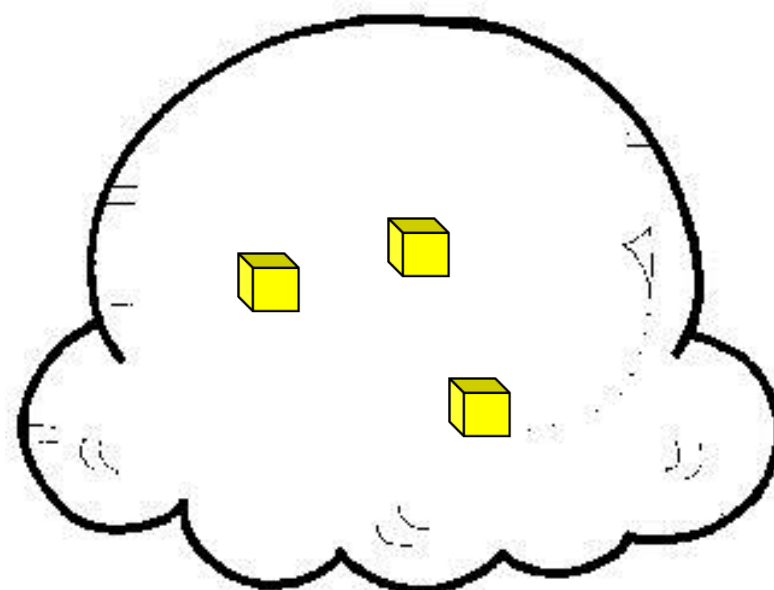
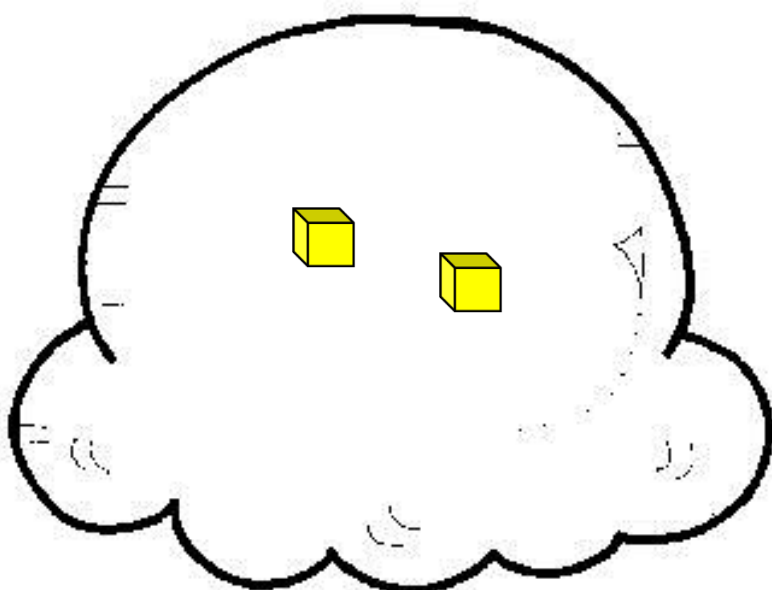
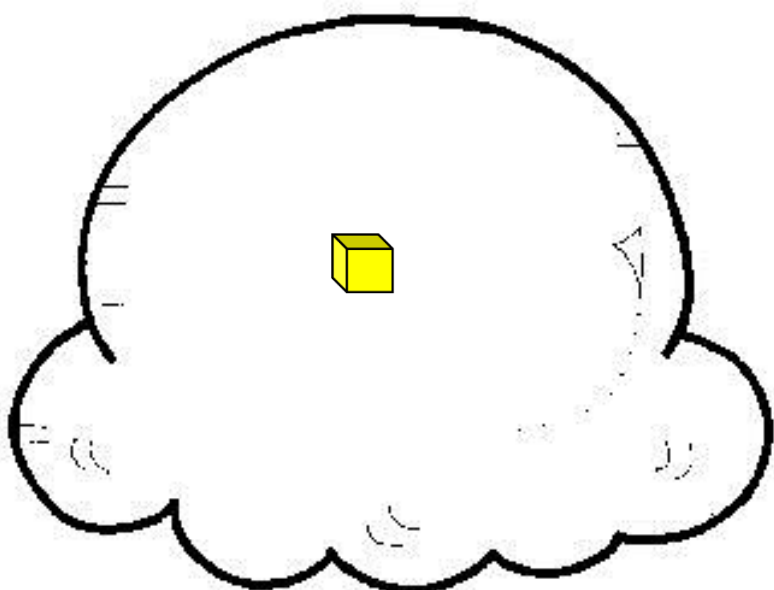
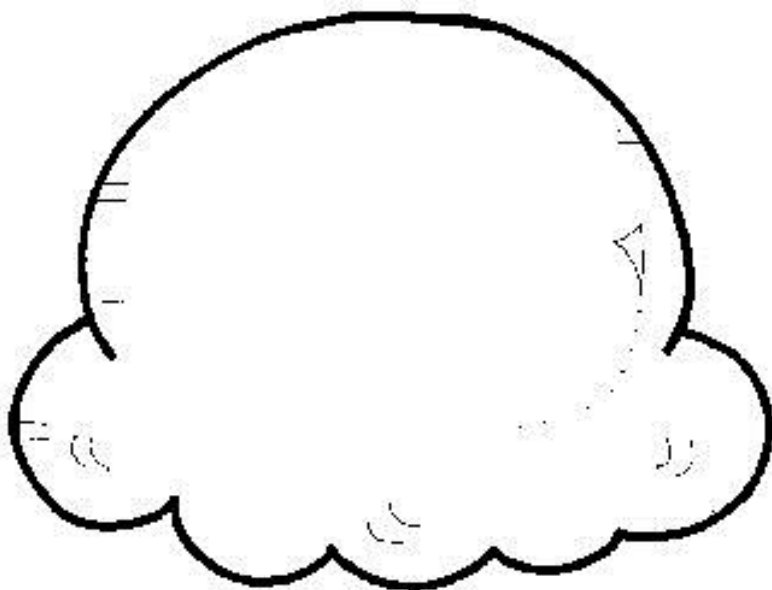

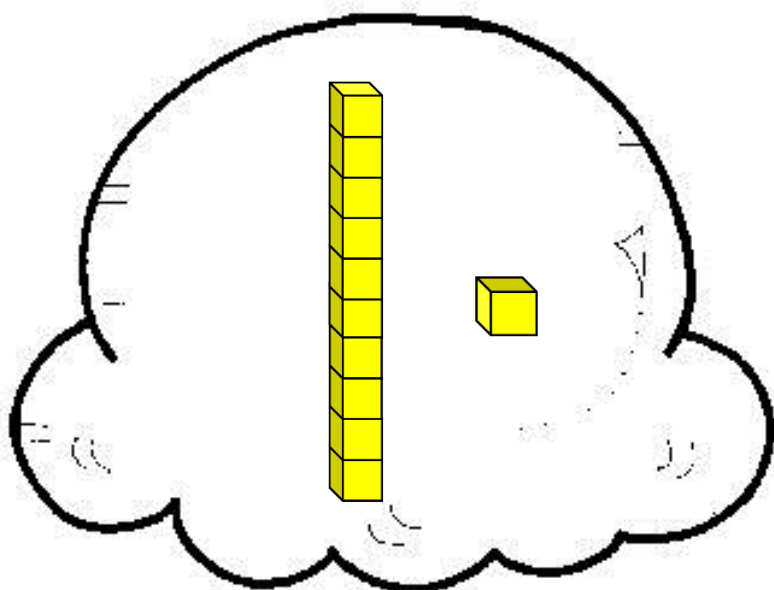
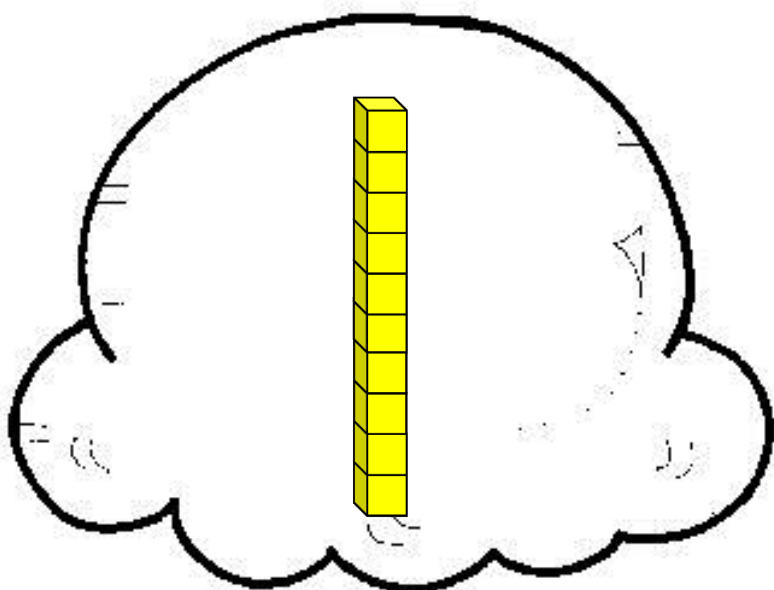
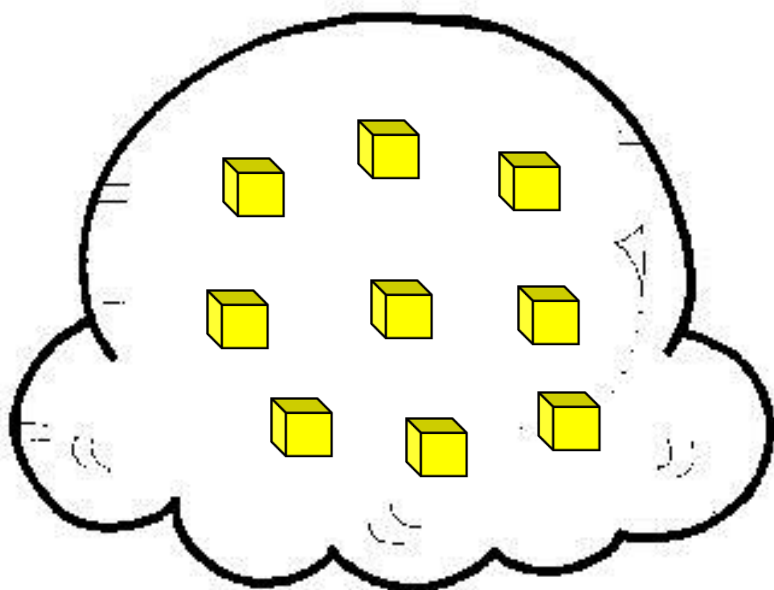
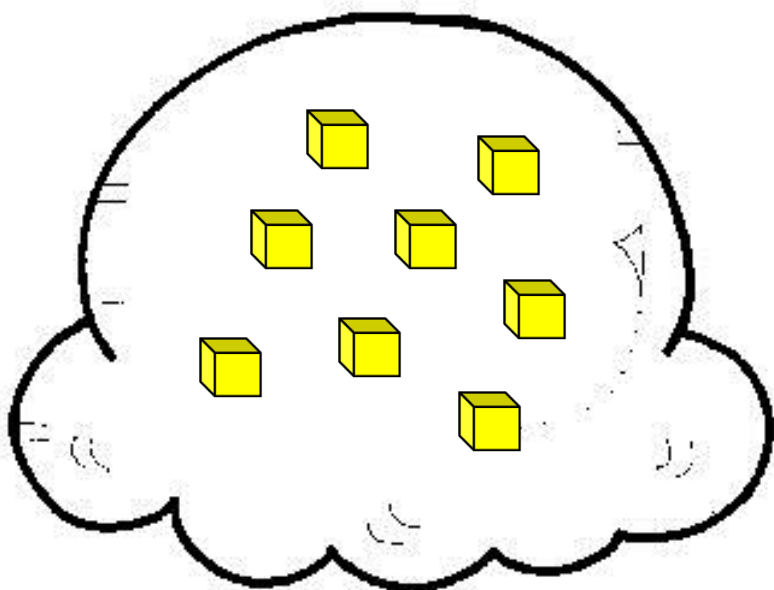
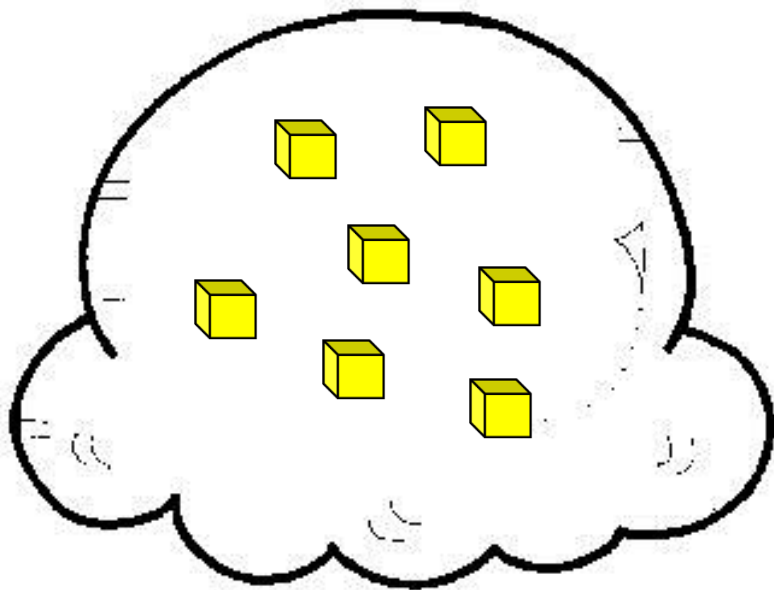
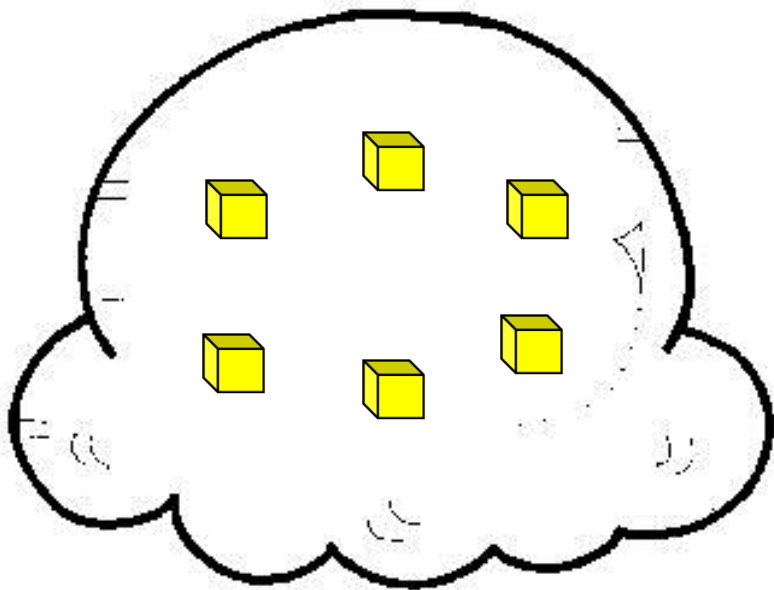

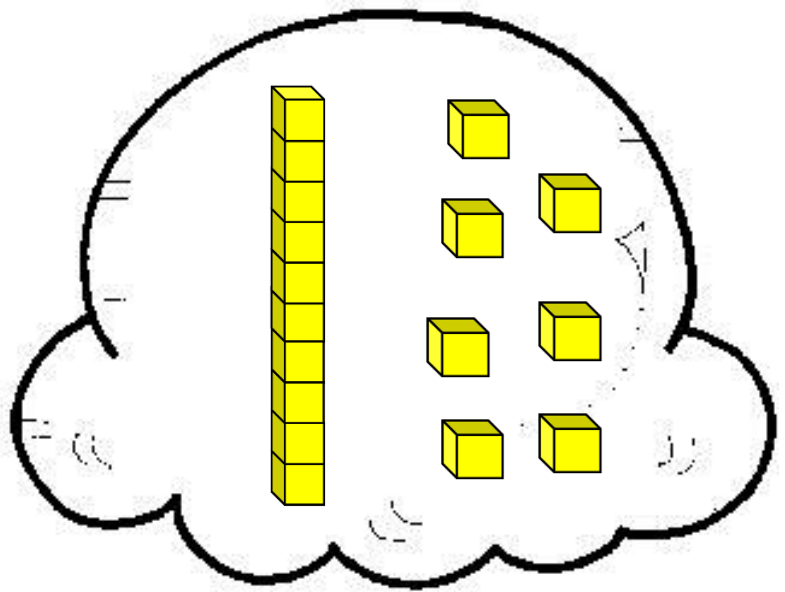
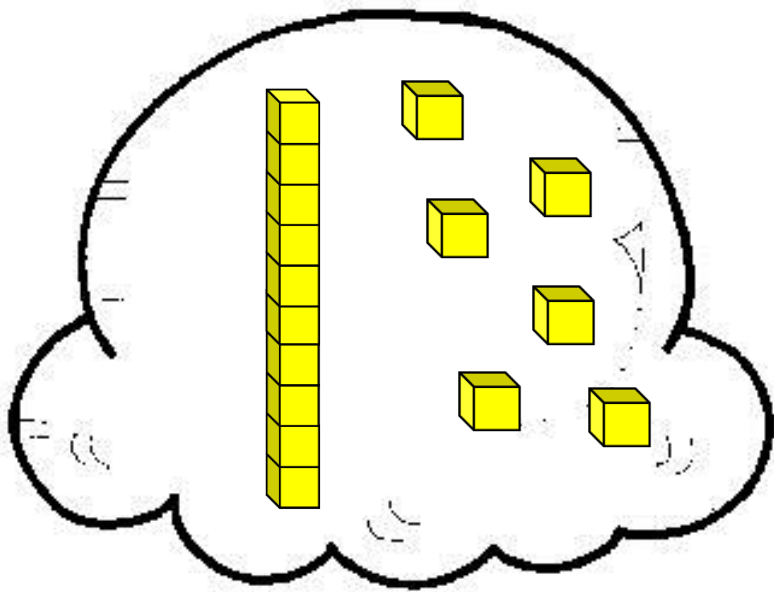
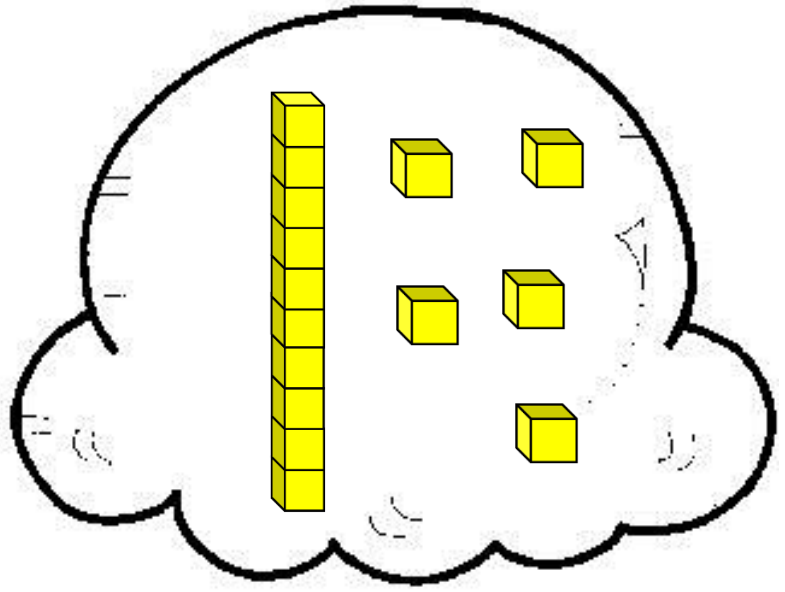
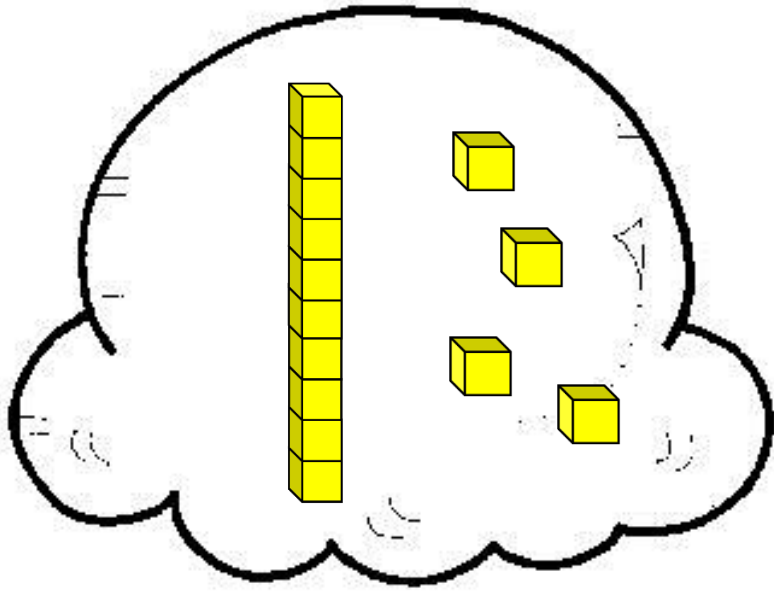
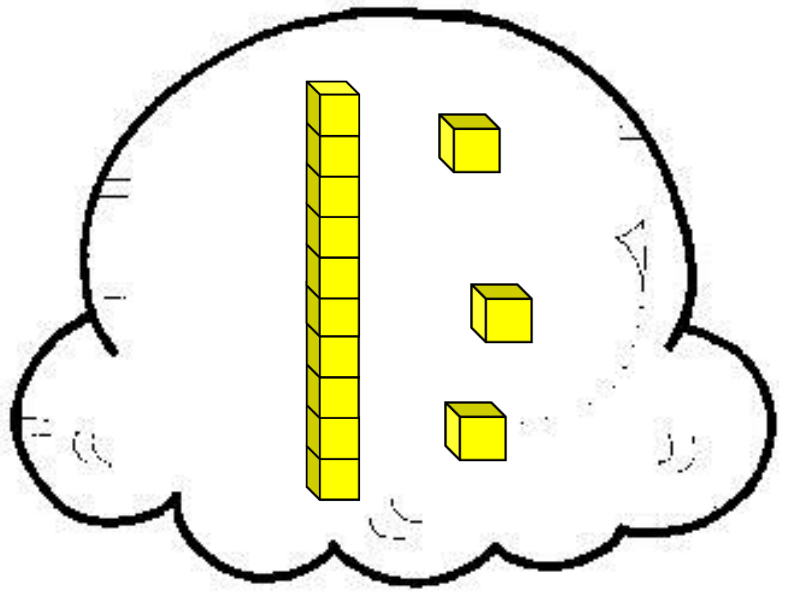
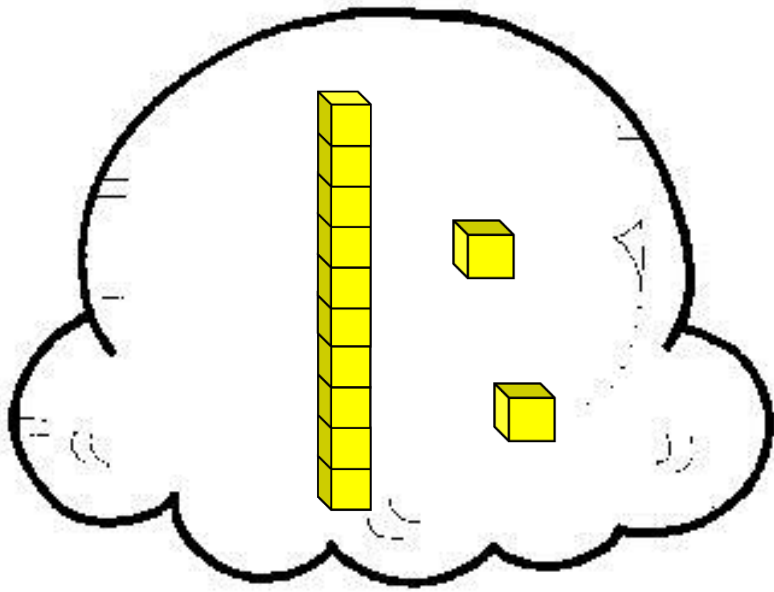

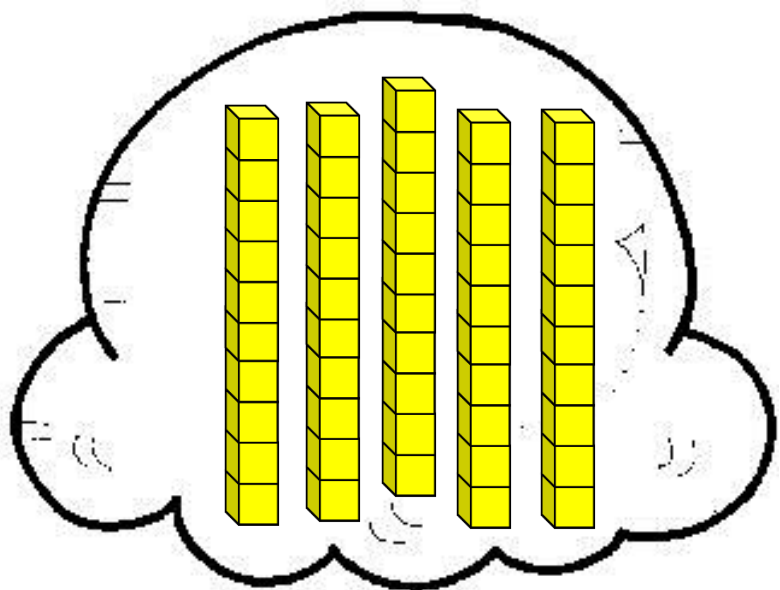
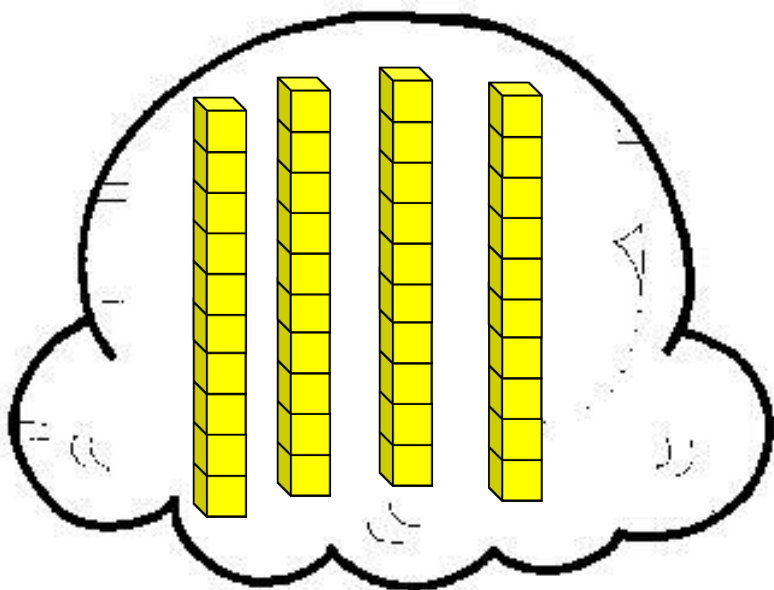
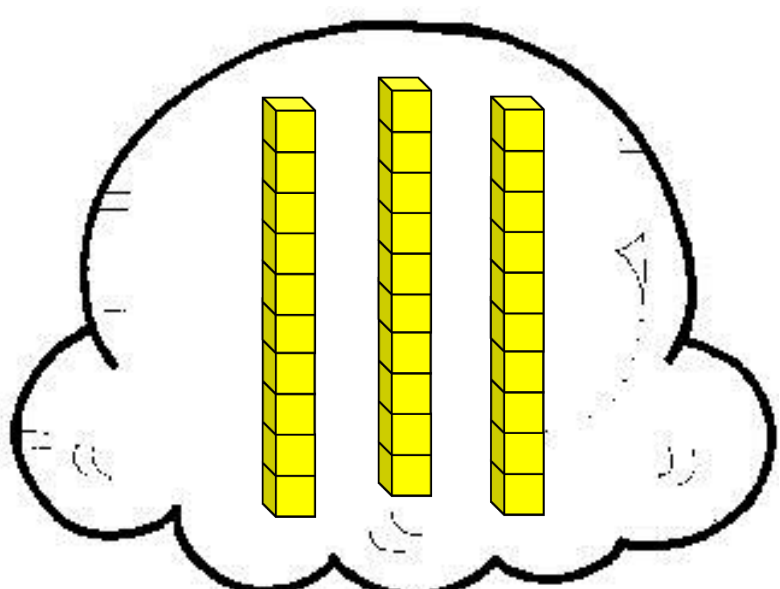
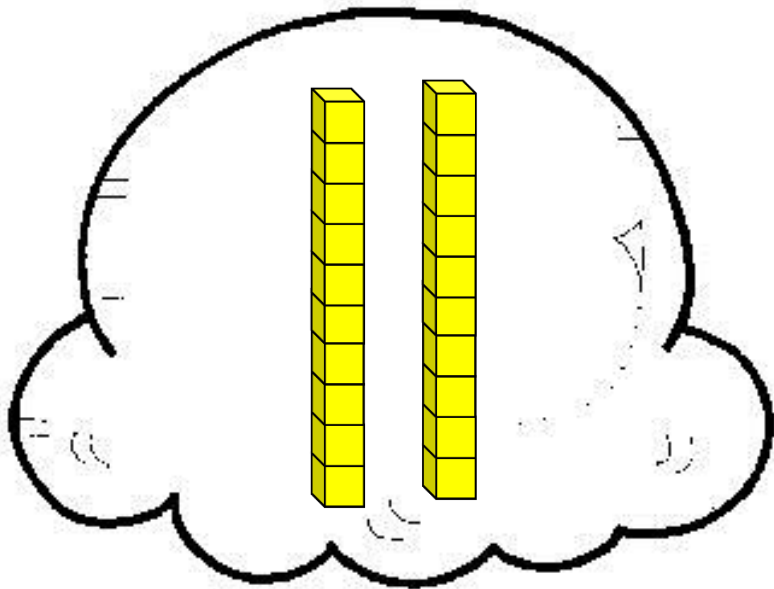
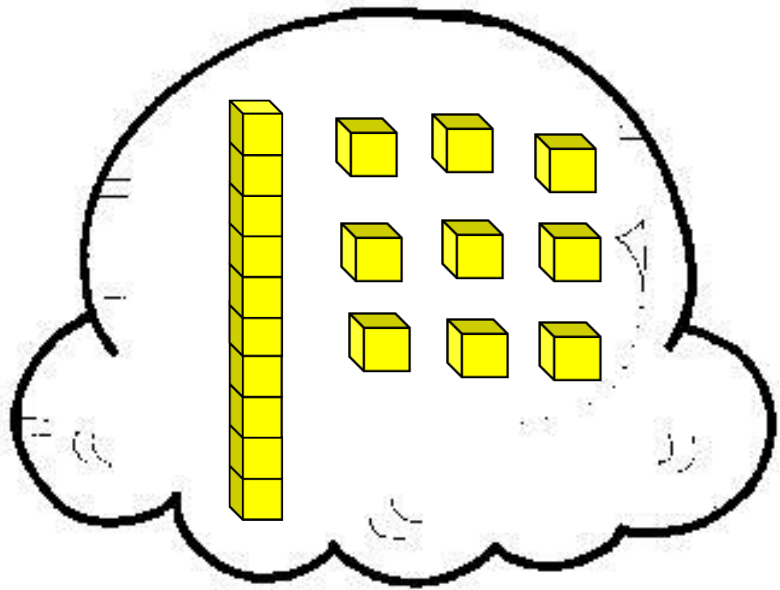
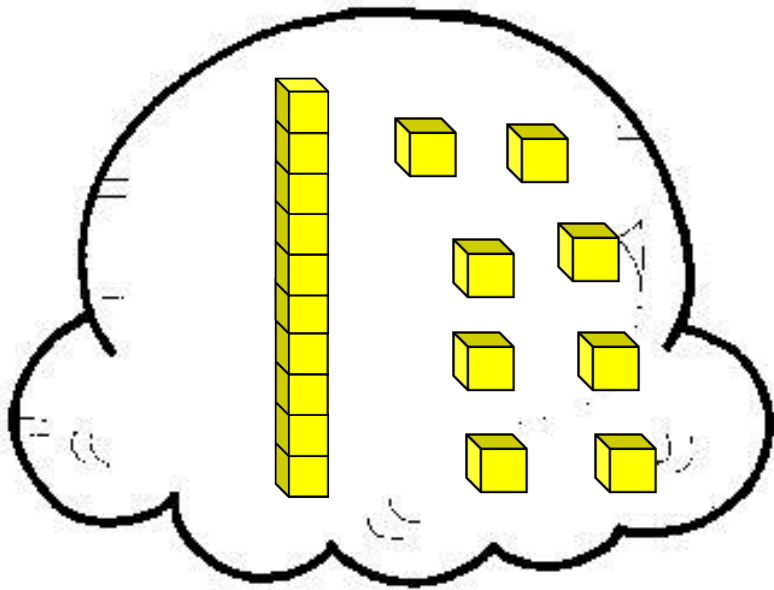

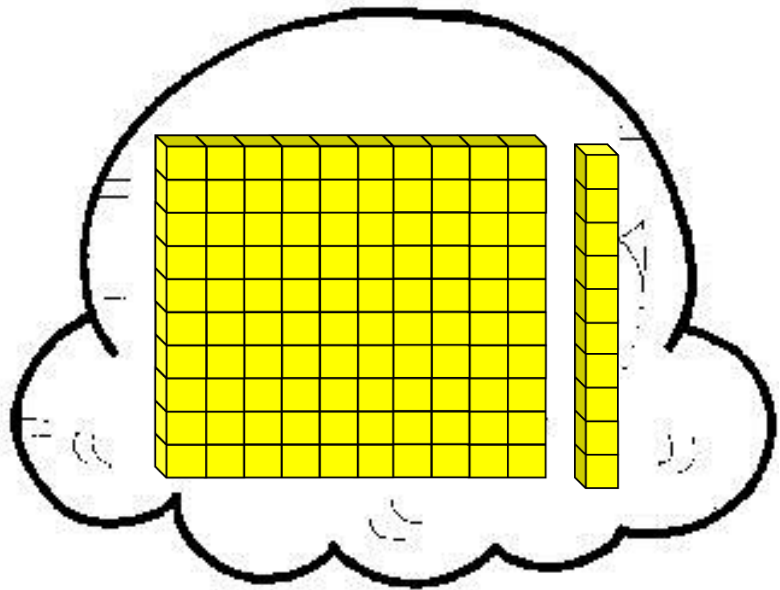
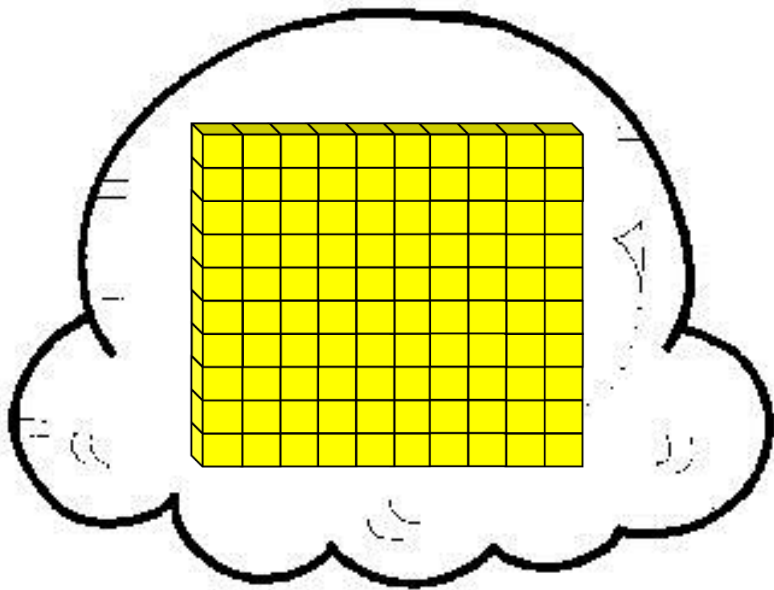
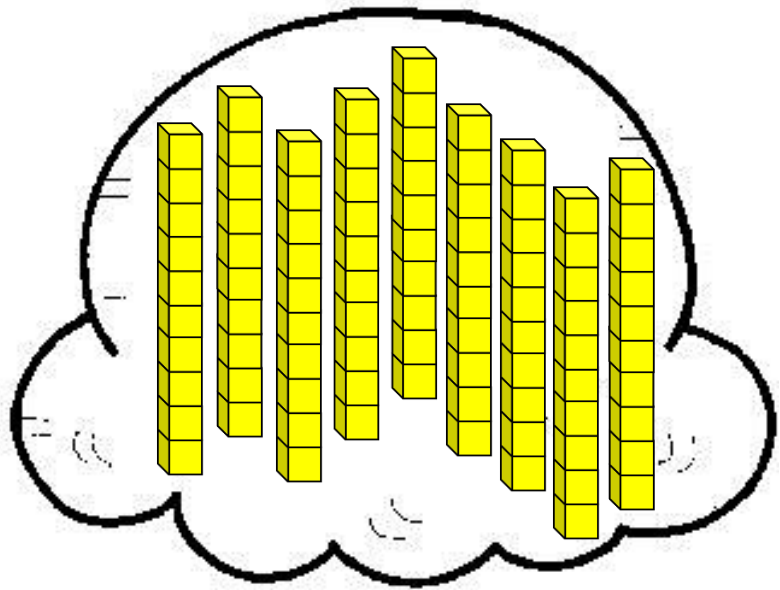
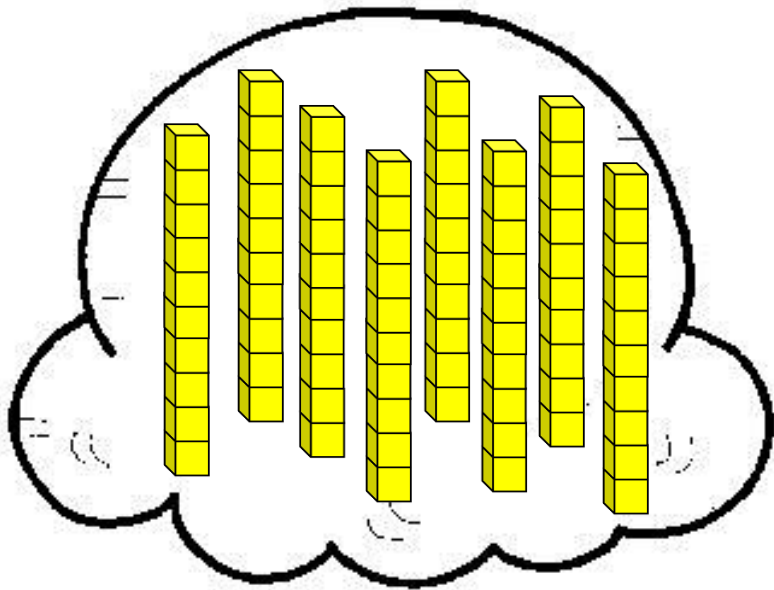
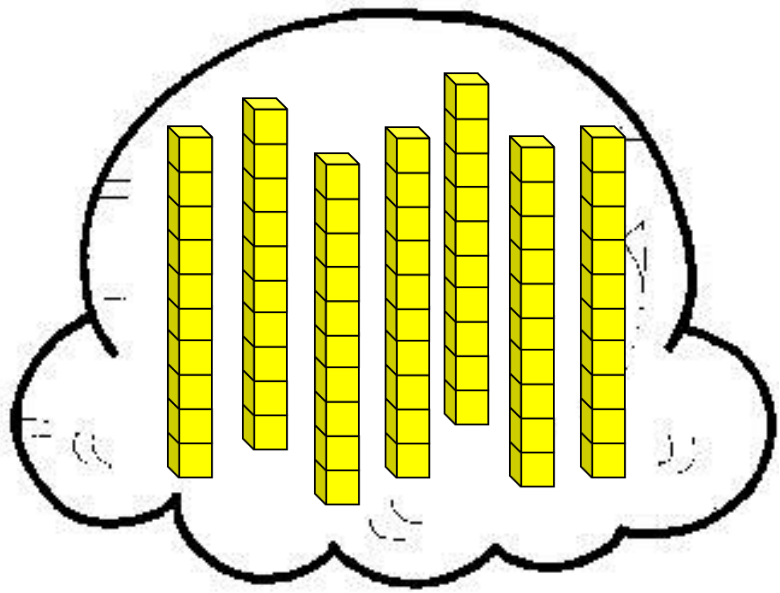
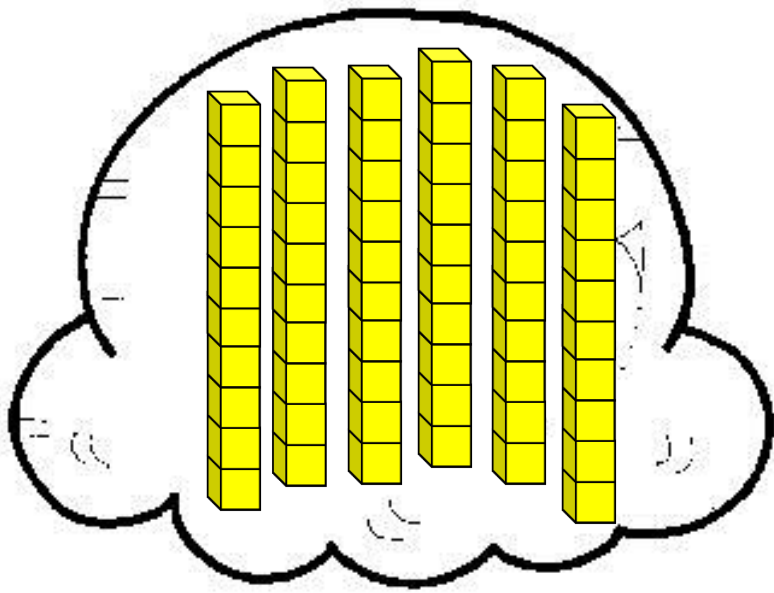



0 tens

0 ones



0 tens

1 one



0 tens

2 ones



0 tens

3 ones



0 tens

4 ones



0 tens

5 ones

0 tens
6 ones

0 tens
7 ones

0 tens
8 ones

0 tens
9 ones

1 ten
0 ones

1 ten
1 one

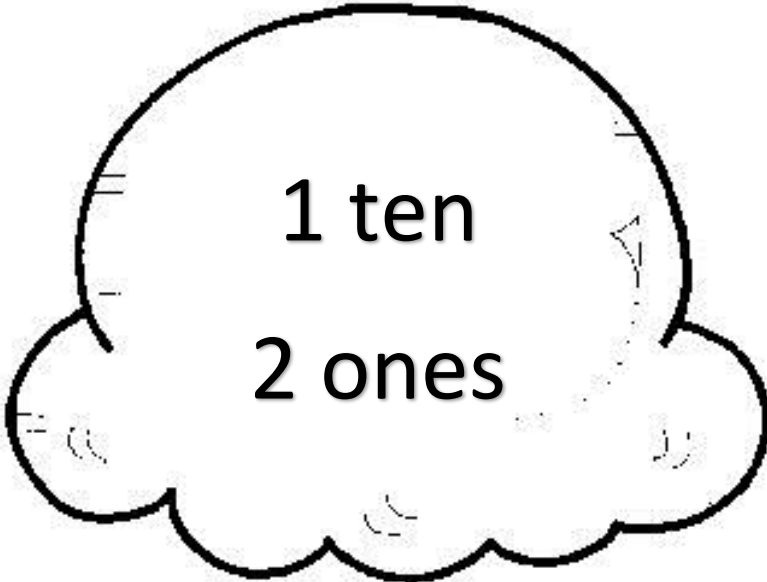
A cloud-shaped box with a scalloped bottom edge and a thick black outline. Inside, the text "1 ten" and "2 ones" is centered.

1 ten
2 ones

A cloud-shaped box with a scalloped bottom edge and a thick black outline. Inside, the text "1 ten" and "3 ones" is centered.

1 ten
3 ones

A cloud-shaped box with a scalloped bottom edge and a thick black outline. Inside, the text "1 ten" and "4 ones" is centered.

1 ten
4 ones

A cloud-shaped box with a scalloped bottom edge and a thick black outline. Inside, the text "1 ten" and "5 ones" is centered.

1 ten
5 ones

A cloud-shaped box with a scalloped bottom edge and a thick black outline. Inside, the text "1 ten" and "6 ones" is centered.

1 ten
6 ones

A cloud-shaped box with a scalloped bottom edge and a thick black outline. Inside, the text "1 ten" and "7 ones" is centered.

1 ten
7 ones

A cloud-shaped box with a scalloped bottom edge and a thick black outline. Inside, the text "1 ten" and "8 ones" is centered.

1 ten
8 ones

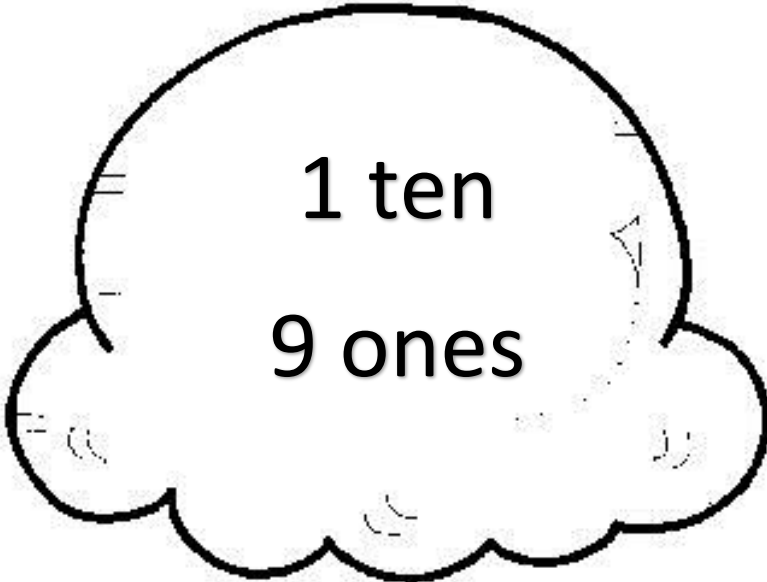
A cloud-shaped box with a scalloped bottom edge and a thick black outline. Inside, the text "1 ten" and "9 ones" is centered.

1 ten
9 ones

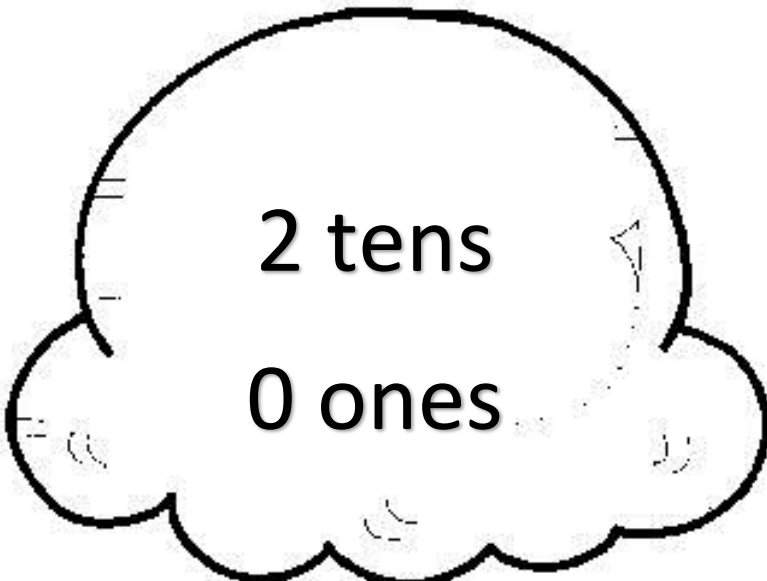
A cloud-shaped box with a scalloped bottom edge and a thick black outline. Inside, the text "2 tens" and "0 ones" is centered.

2 tens
0 ones

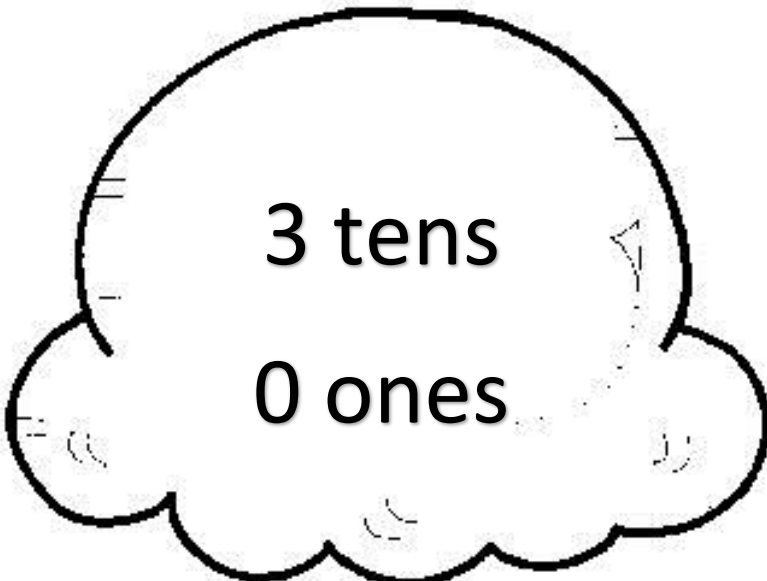
A cloud-shaped box with a scalloped bottom edge and a thick black outline. Inside, the text "3 tens" and "0 ones" is centered.

3 tens
0 ones

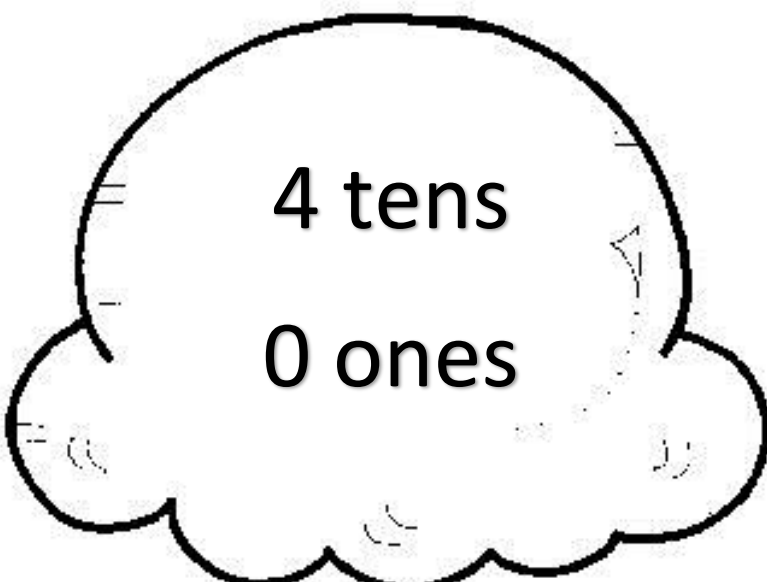
A cloud-shaped box with a scalloped bottom edge and a thick black outline. Inside, the text "4 tens" and "0 ones" is centered.

4 tens
0 ones

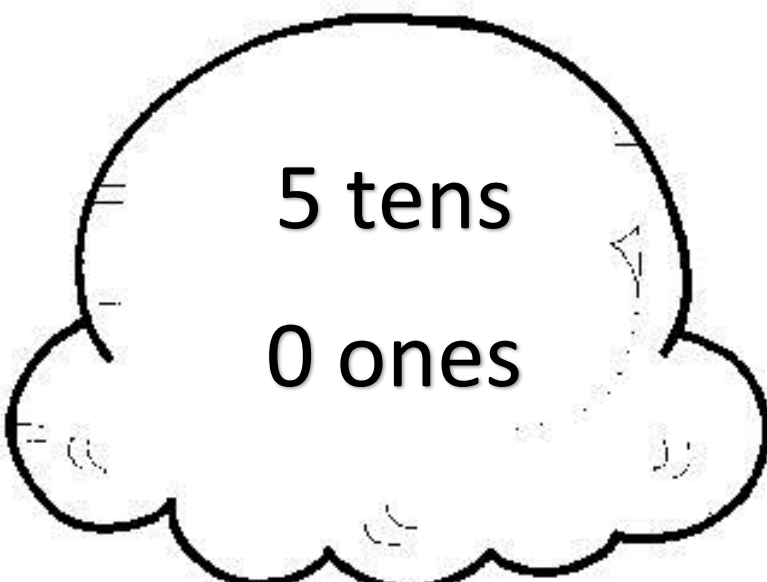
A cloud-shaped box with a scalloped bottom edge and a thick black outline. Inside, the text "5 tens" and "0 ones" is centered.

5 tens
0 ones

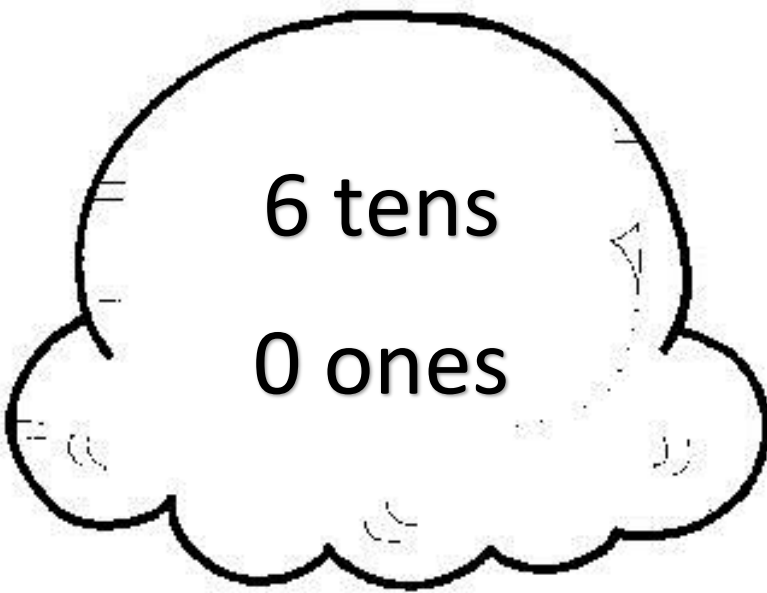

6 tens
0 ones

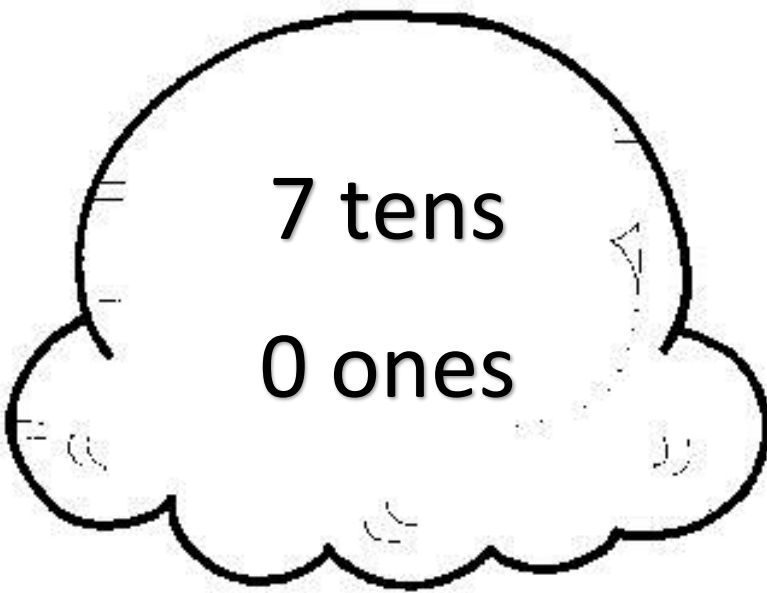

7 tens
0 ones

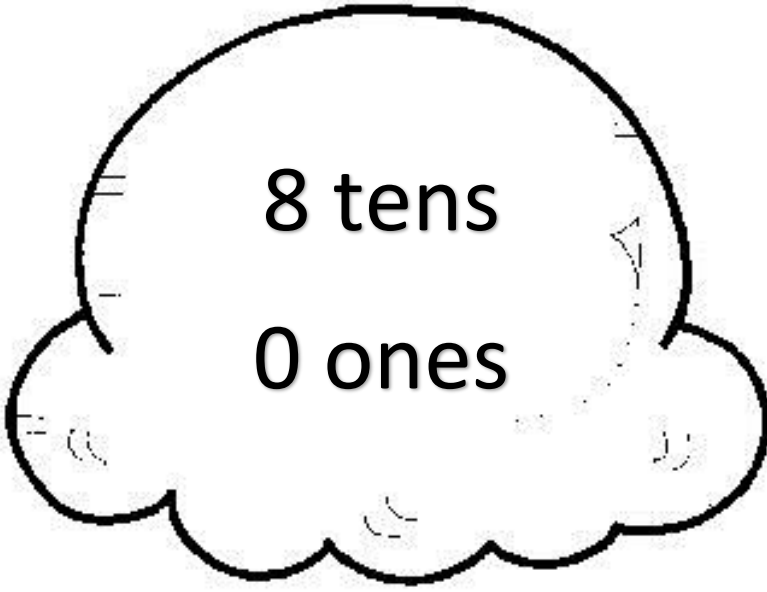

8 tens
0 ones

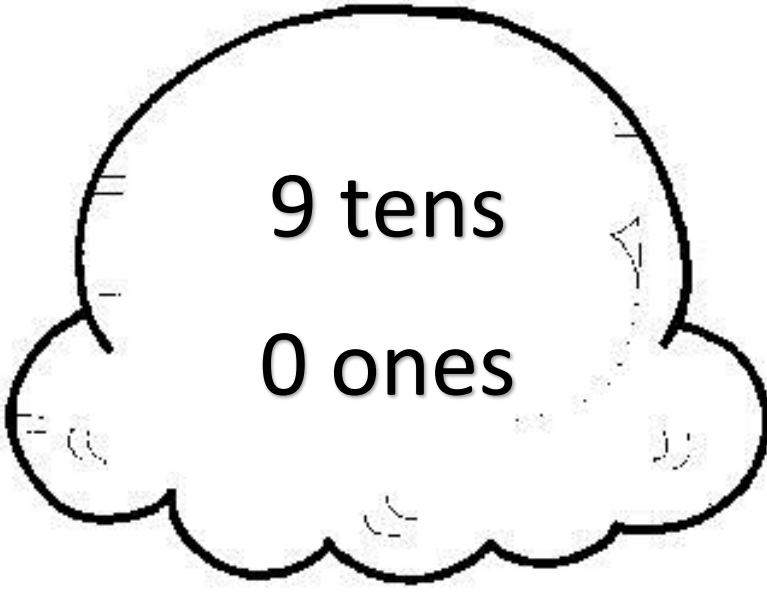

9 tens
0 ones

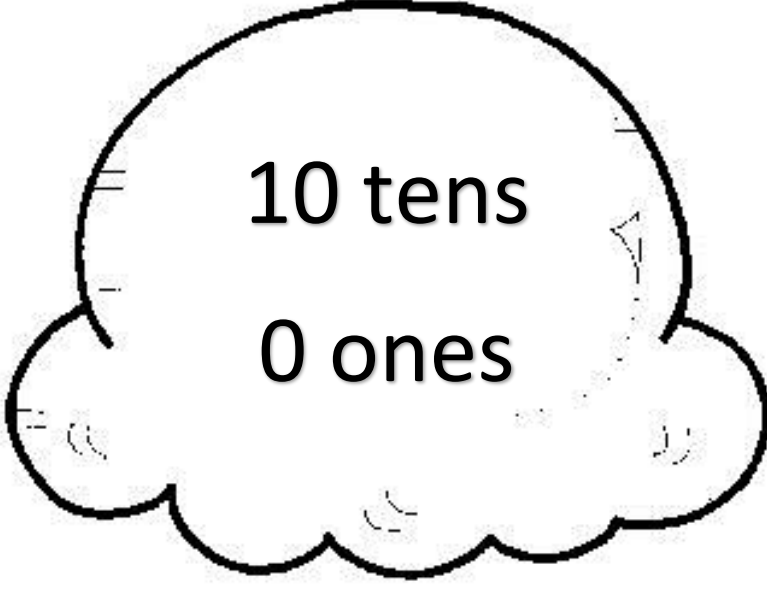

10 tens
0 ones

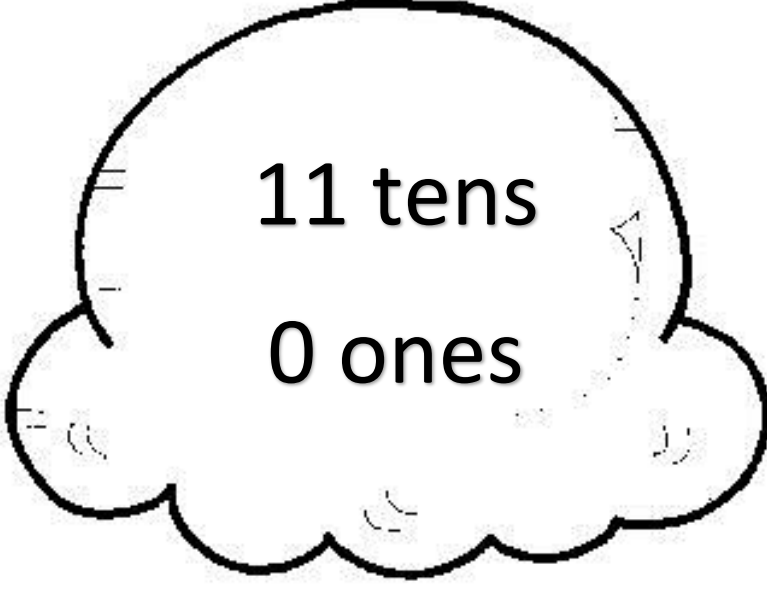

11 tens
0 ones

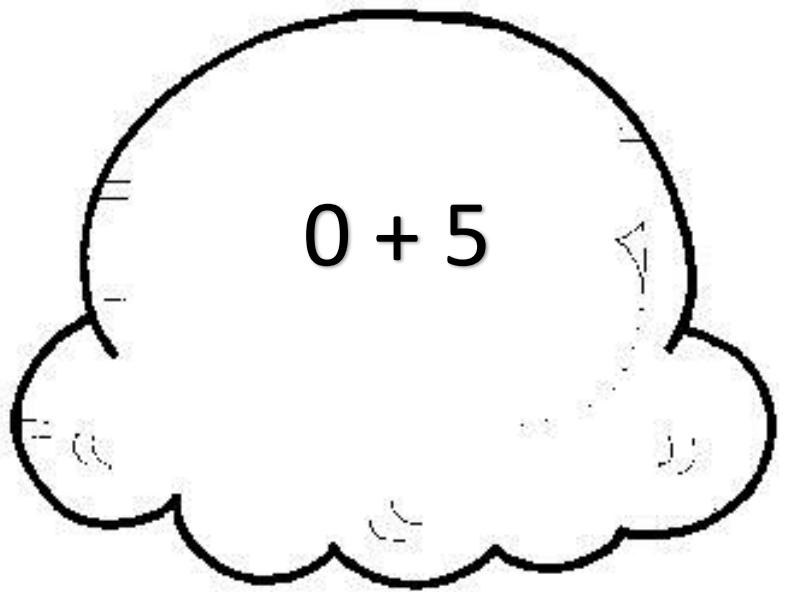
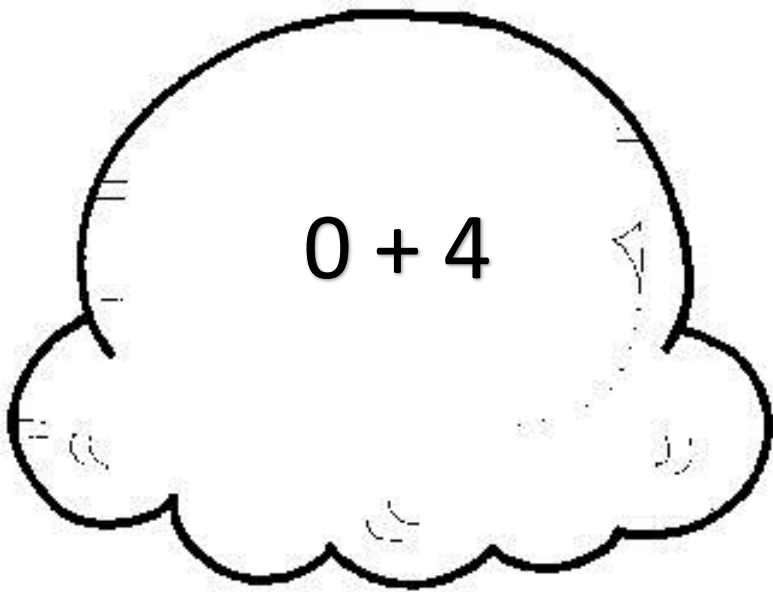
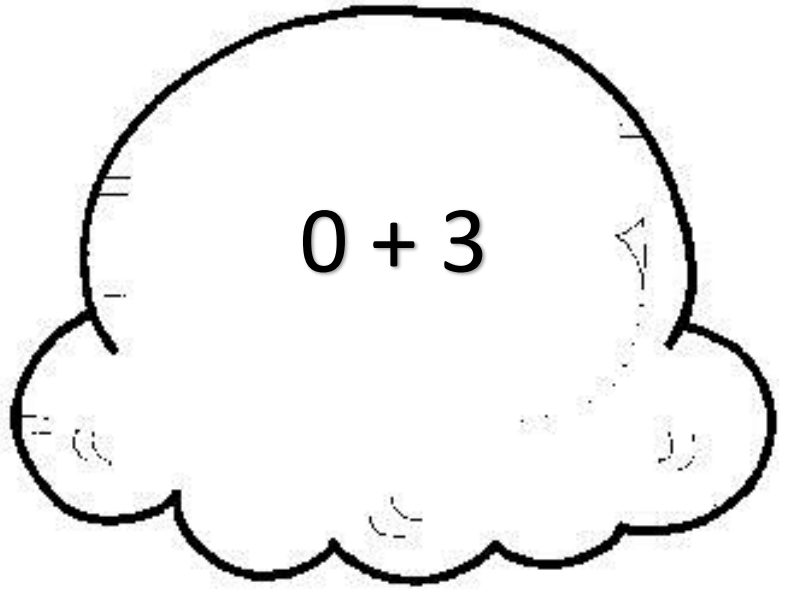
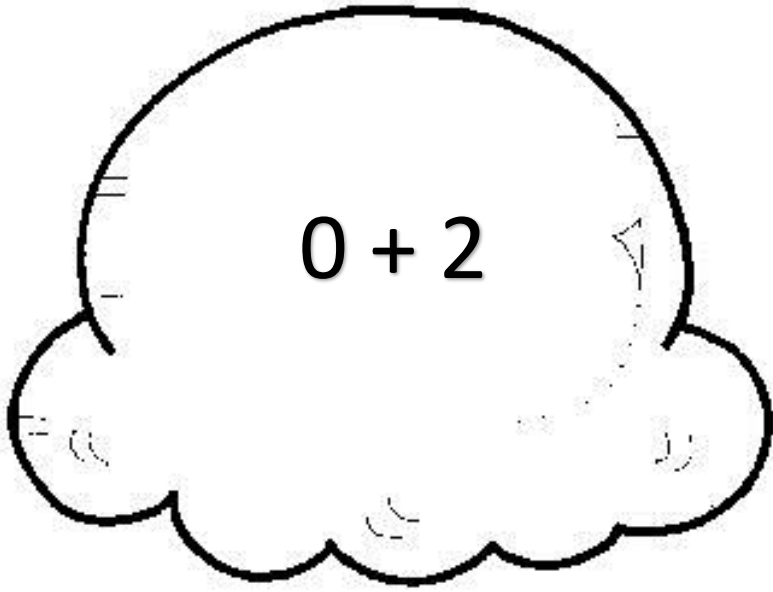
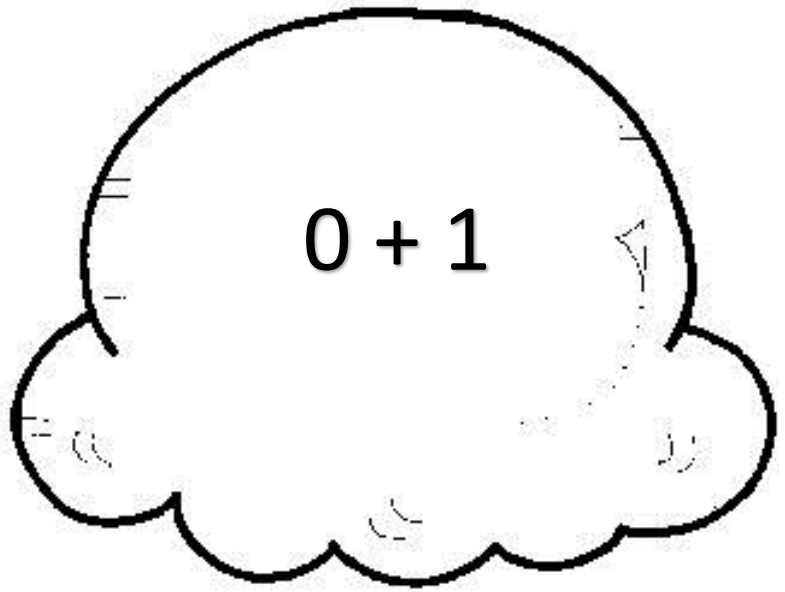
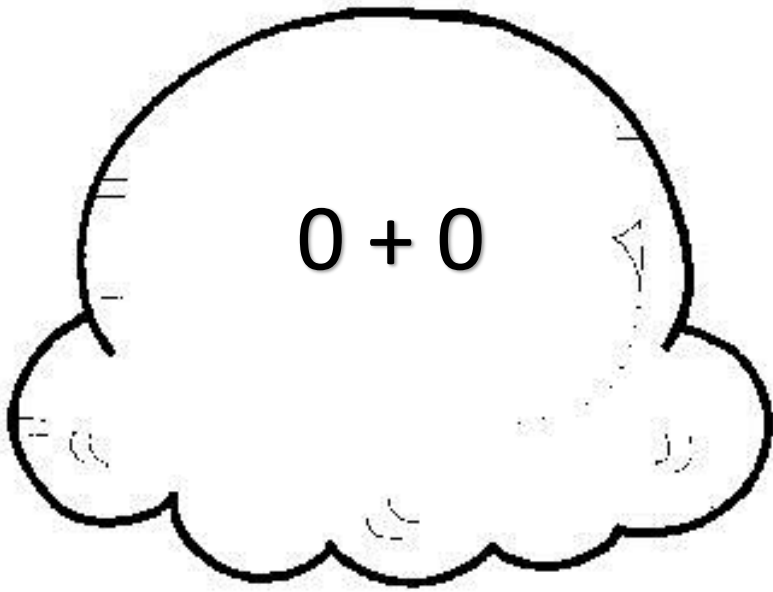



$0 + 6$

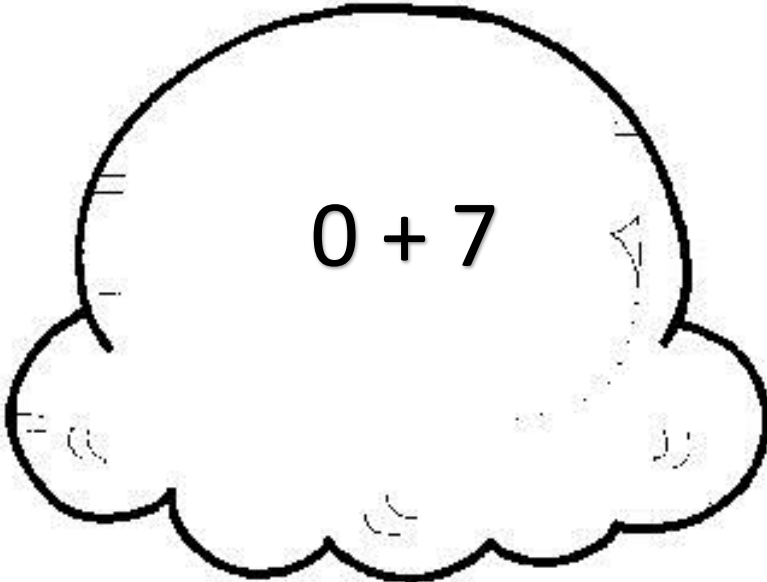

$0 + 7$



$0 + 8$

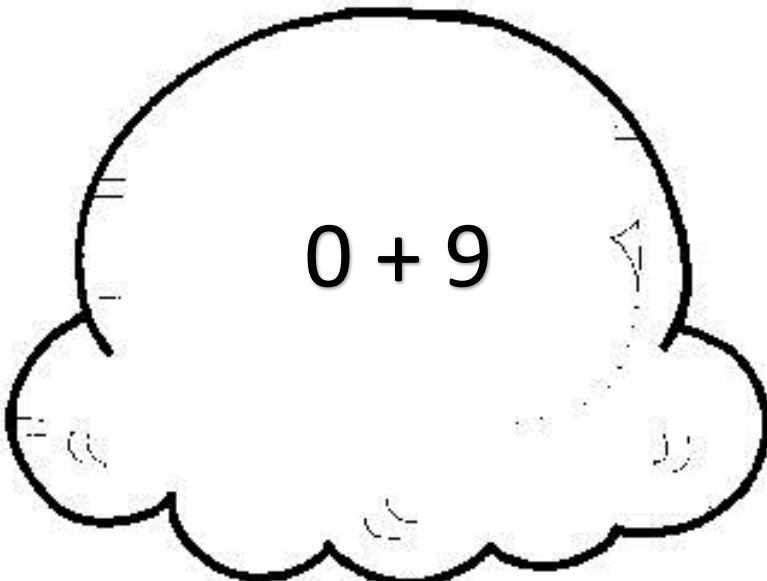

$0 + 9$

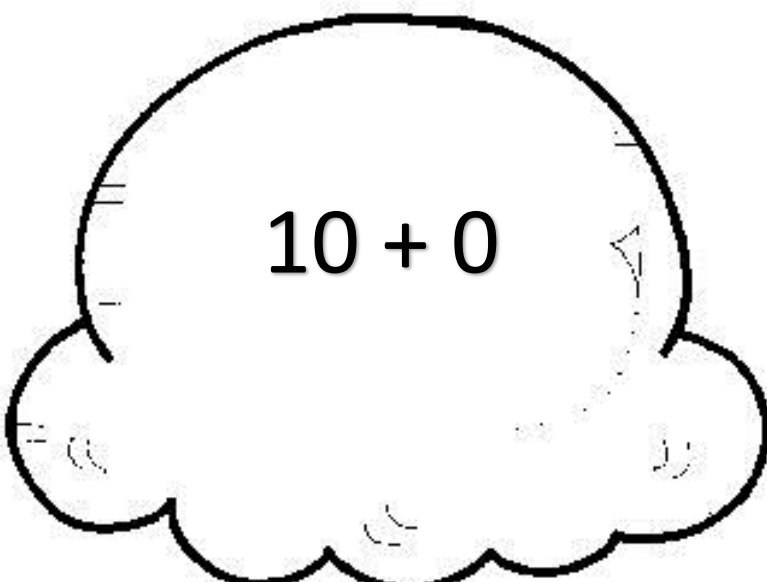

$10 + 0$

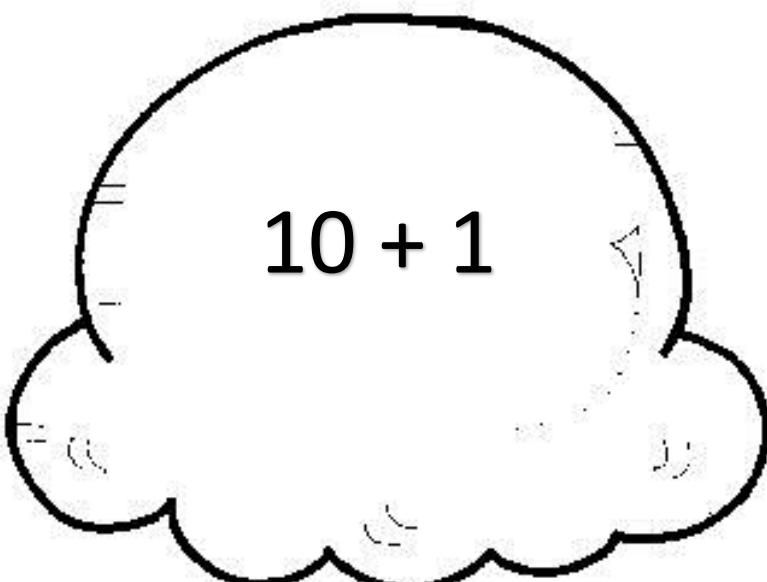

$10 + 1$

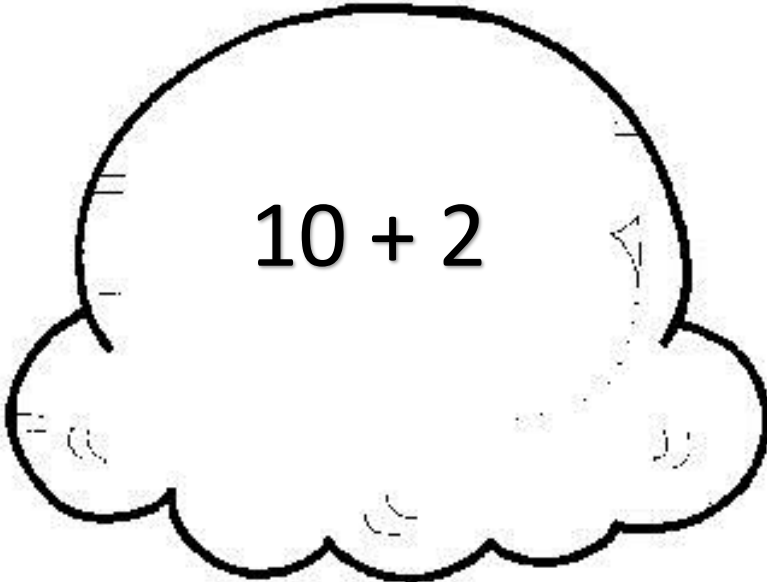
 $10 + 2$

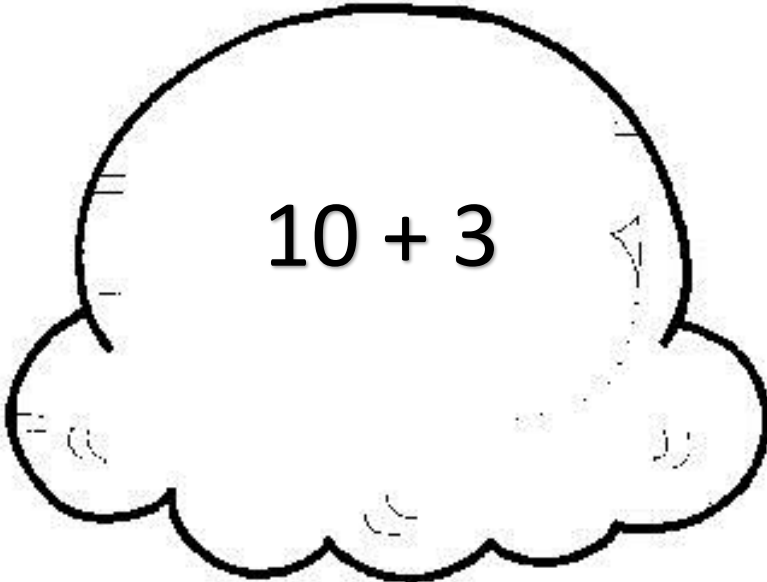
 $10 + 3$

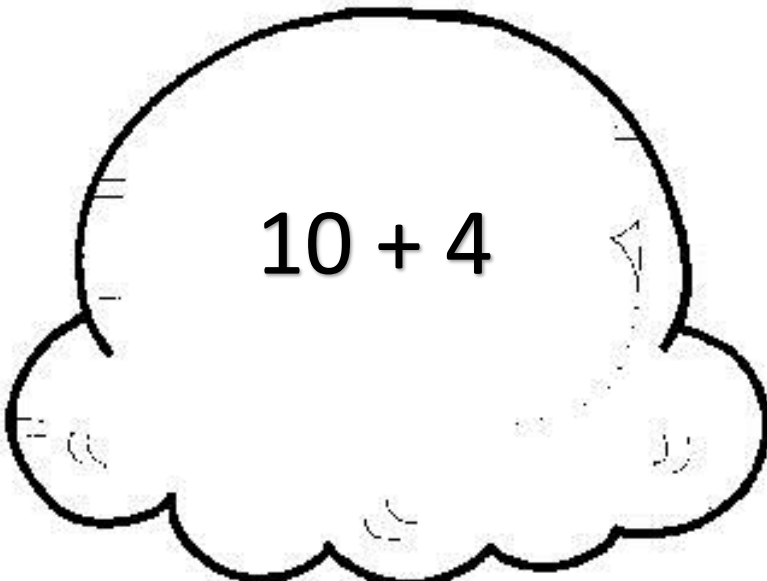
 $10 + 4$

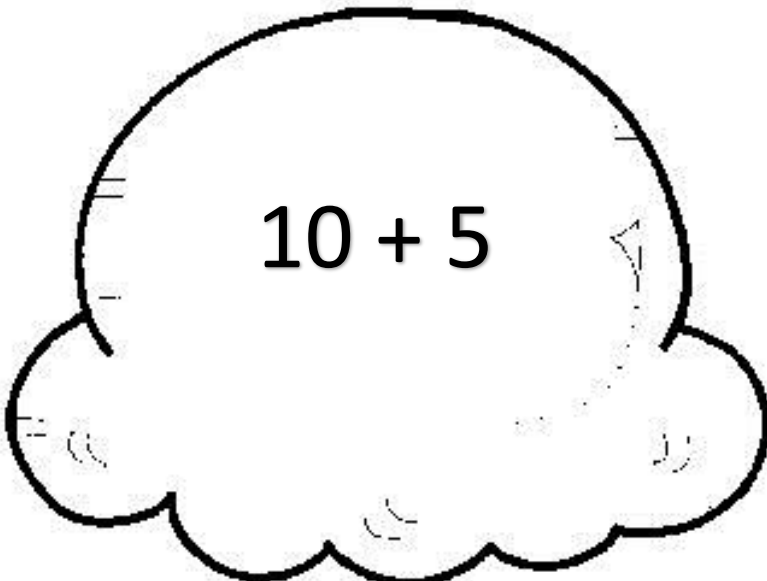
 $10 + 5$

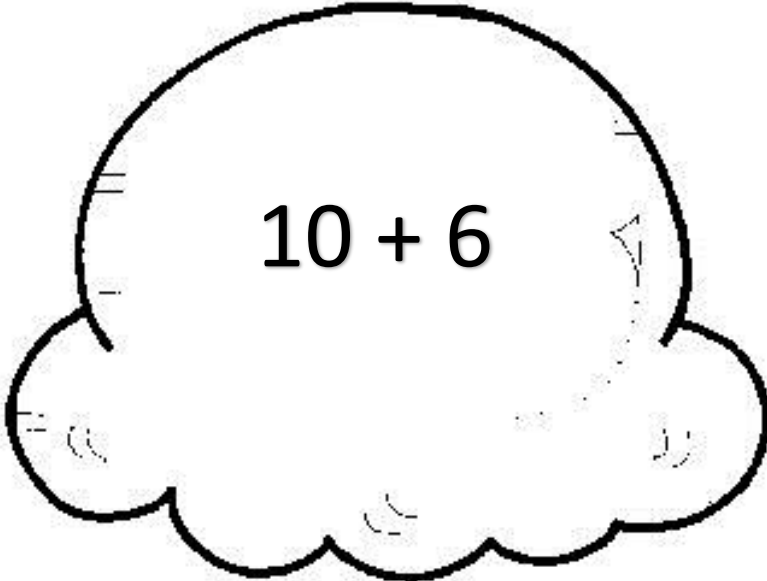
 $10 + 6$

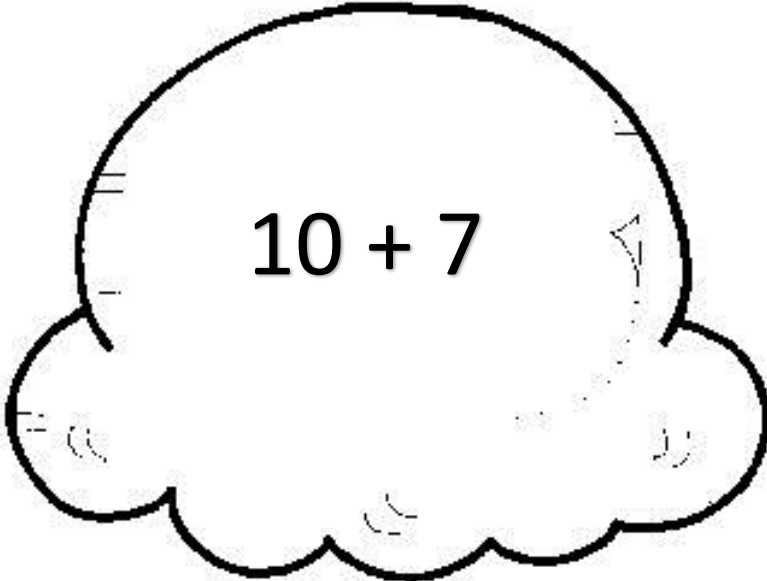
 $10 + 7$

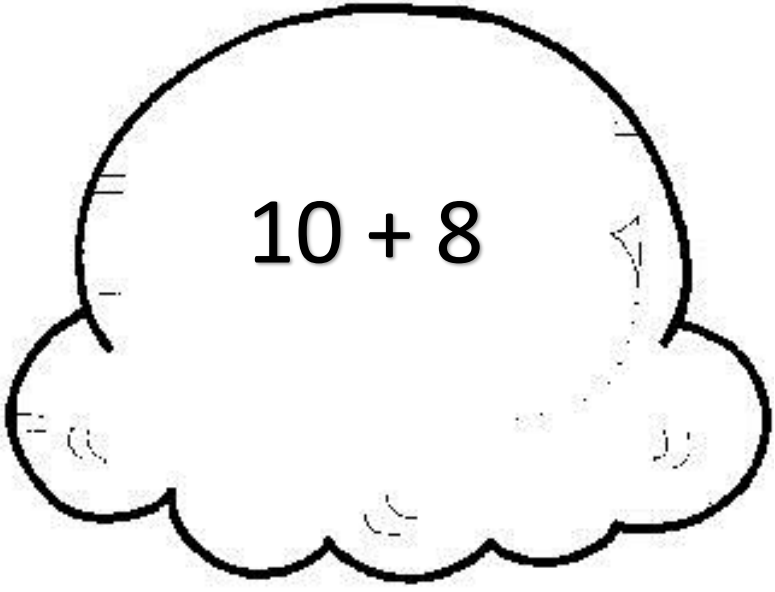
 $10 + 8$

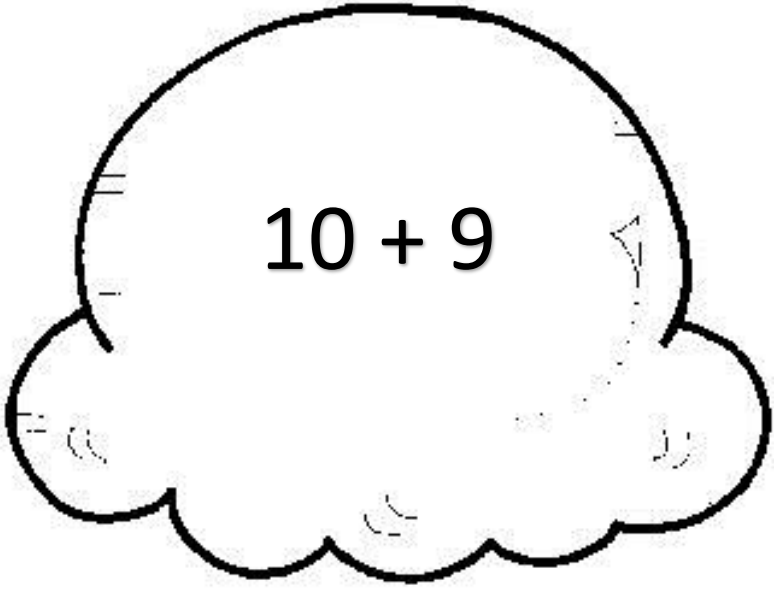
 $10 + 9$

 $10 + 10$

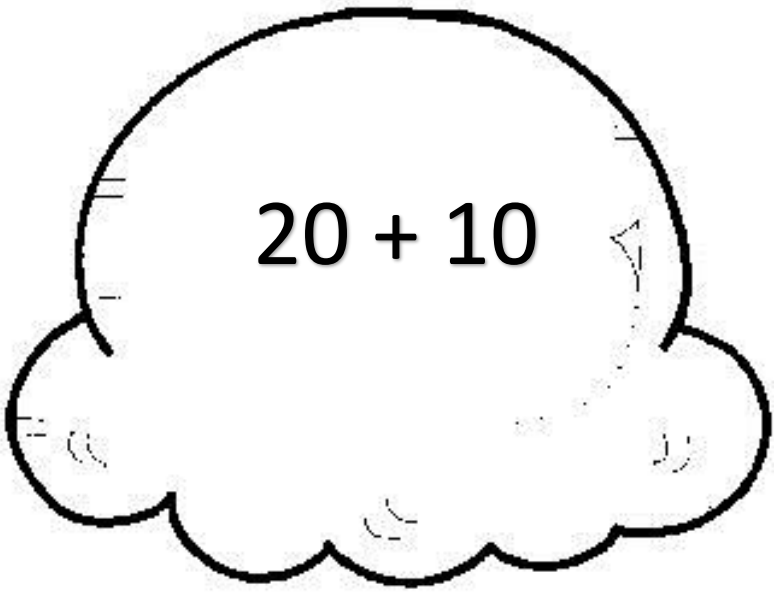
 $20 + 10$

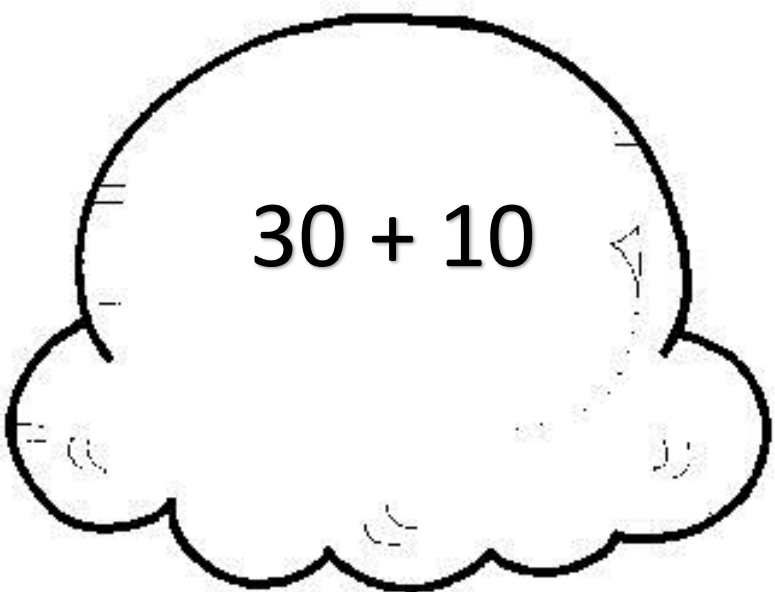
 $30 + 10$

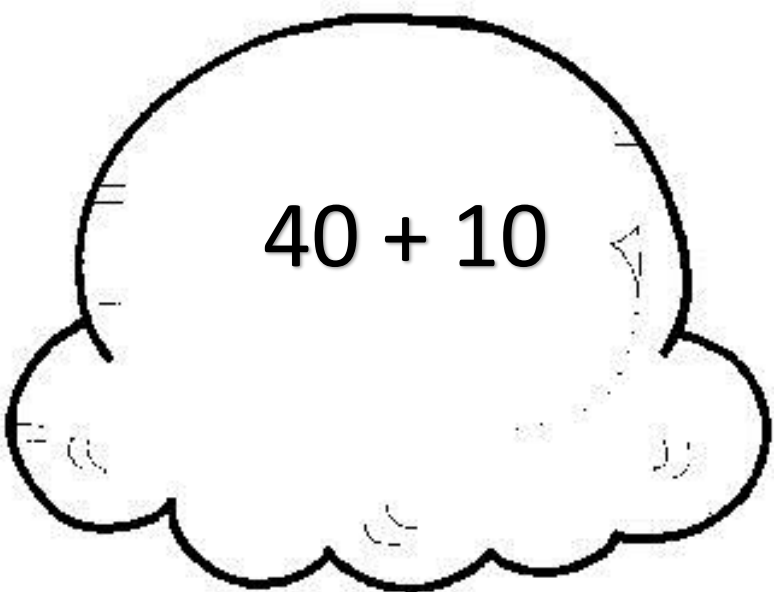
 $40 + 10$

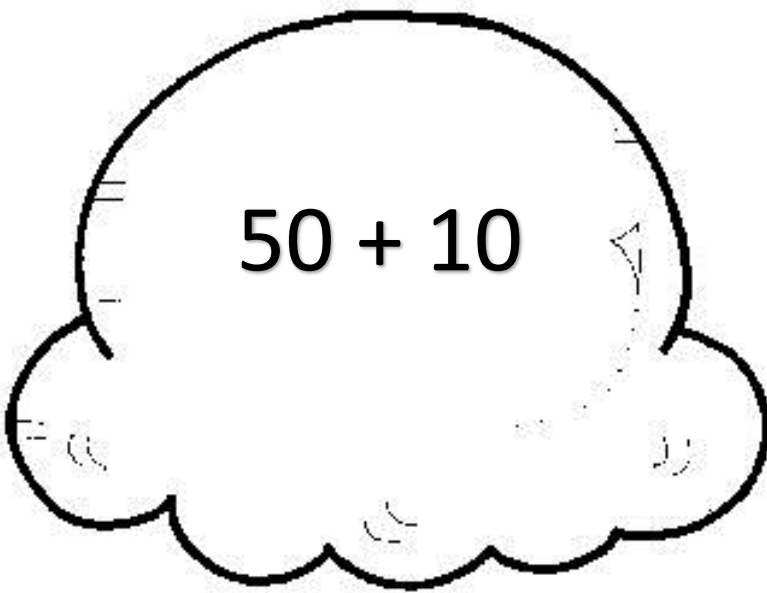

$$50 + 10$$

$$60 + 10$$

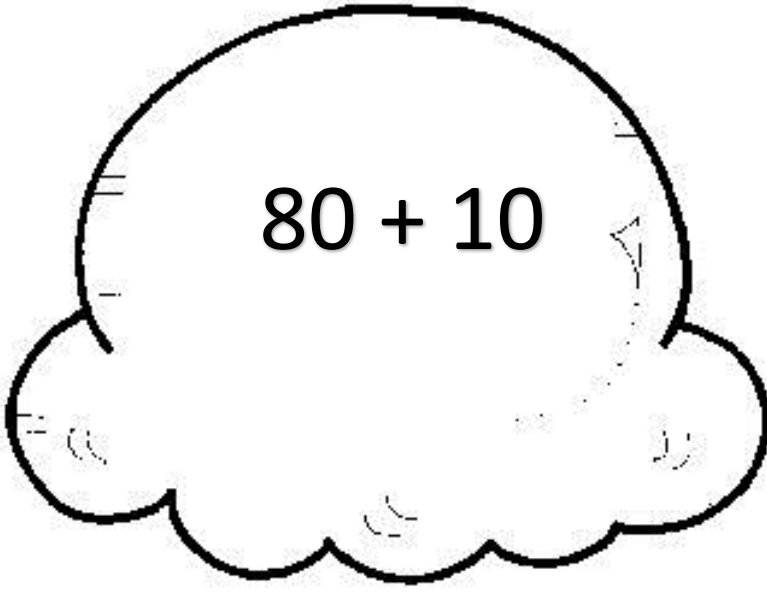
$$70 + 10$$

$$80 + 10$$

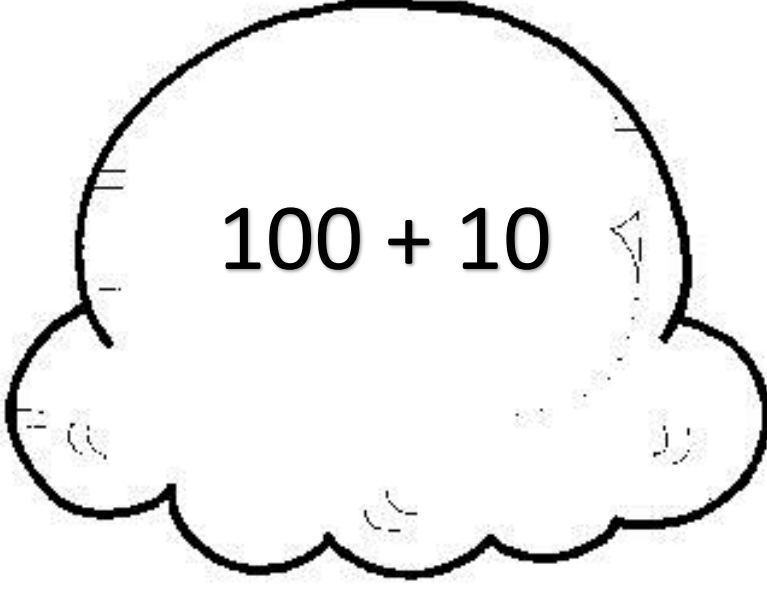
$$90 + 10$$

$$100 + 10$$

